

G1000[™]

*Cockpit Reference Guide
for the Cessna Nav III*

Copyright © 2004, 2005 Garmin Ltd. or its subsidiaries. All rights reserved.

This manual reflects the operation of System Software versions 0394.06 or later for Cessna 172R aircraft, 0395.07 or later for Cessna 172S aircraft, 0371.15 or later for normally aspirated Cessna 182 aircraft, 0372.14 or later for turbocharged Cessna 182 aircraft, 0373.10 or later for normally aspirated Cessna 206 aircraft, and 0374.10 or later for turbocharged Cessna 206 aircraft. Some differences in operation may be observed when comparing the information in this manual to earlier or later software versions.



NOTE: *Cessna Nav III aircraft include the Cessna 172R, the Cessna 172S, the normally aspirated Cessna 182 (182), the turbocharged Cessna 182 (T182), the normally aspirated Cessna 206 (206), and the turbocharged Cessna 206 (T206). Unless otherwise indicated, information in the G1000 Cockpit Reference Guide pertains to all Cessna Nav III aircraft.*

Garmin International, Inc., 1200 East 151st Street, Olathe, Kansas 66062, U.S.A.
Tel: 913/397.8200 Fax: 913/397.8282

Garmin AT, Inc., 2345 Turner Road SE, Salem, OR 97302, U.S.A.
Tel: 503/391.3411 Fax 503/364.2138

Garmin (Europe) Ltd., Unit 5, The Quadrangle, Abbey Park Industrial Estate, Romsey, Hampshire S051 9DL, U.K.
Tel: 44/0870.8501241 Fax: 44/0870.8501251

Garmin Corporation, No. 68, Jangshu 2nd Road, Shijr, Taipei County, Taiwan
Tel: 886/02.2642.9199 Fax: 886/02.2642.9099

Web Site Address: www.garmin.com

Except as expressly provided herein, no part of this manual may be reproduced, copied, transmitted, disseminated, downloaded or stored in any storage medium, for any purpose without the express written permission of Garmin. Garmin hereby grants permission to download a single copy of this manual and of any revision to this manual onto a hard drive or other electronic storage medium to be viewed for personal use, provided that such electronic or printed copy of this manual or revision must contain the complete text of this copyright notice and provided further that any unauthorized commercial distribution of this manual or any revision hereto is strictly prohibited.

Garmin® is a registered trademark of Garmin Ltd. or its subsidiaries, and G1000™ is a trademark of Garmin Ltd. or its subsidiaries. These trademarks may not be used without the express permission of Garmin.

NavData® is a registered trademark of Jeppesen, Inc.; Stormscope® is a registered trademark of L-3 Communications; and XM® is a registered trademark of XM Satellite Radio, Inc., Honeywell® and Bendix/King® are registered trademarks of Honeywell International, Inc.; CO Guardian is a trademark of CO Guardian, Inc.



WARNING: Navigation and terrain separation must NOT be predicated upon the use of the terrain function. The G1000 Terrain Proximity feature is NOT intended to be used as a primary reference for terrain avoidance and does not relieve the pilot from the responsibility of being aware of surroundings during flight. The Terrain Proximity feature is only to be used as an aid for terrain avoidance and is not certified for use in applications requiring a certified terrain awareness system. Terrain data is obtained from third party sources. Garmin is not able to independently verify the accuracy of the terrain data.



WARNING: The displayed minimum safe altitudes (MSAs) are only advisory in nature and should not be relied upon as the sole source of obstacle and terrain avoidance information. Always refer to current aeronautical charts for appropriate minimum clearance altitudes.



WARNING: The altitude calculated by G1000 GPS receivers is geometric height above Mean Sea Level and could vary significantly from the altitude displayed by pressure altimeters, such as the GDC 74A Air Data Computer, or other altimeters in aircraft. GPS altitude should never be used for vertical navigation. Always use pressure altitude displayed by the G1000 PFD or other pressure altimeters in aircraft.



WARNING: The Jeppesen database used in the G1000 system must be updated regularly in order to ensure that its information remains current. Updates are released every 28 days. A database information packet is included in the G1000 package. Pilots using an outdated database do so entirely at their own risk.



WARNING: The basemap (land and water data) must not be used for navigation, but rather only for non-navigational situational awareness. Any basemap indication should be compared with other navigation sources.



WARNING: Traffic information shown on the G1000 Multi Function Display is provided as an aid in visually acquiring traffic. Pilots must maneuver the aircraft based only upon ATC guidance or positive visual acquisition of conflicting traffic.



WARNING: Use of the Stormscope interface is not intended for hazardous weather penetration (thunderstorm penetration). Stormscope information, as displayed on the G1000 MFD, is to be used only for weather avoidance, not penetration.



WARNING: The GDL 69 Weather Interface should not be used for hazardous weather penetration. Weather information provided by the GDL 69 is approved only for weather avoidance, not penetration.



WARNING: NEXRAD weather data is to be used for long-range planning purposes only. Due to inherent delays in data transmission and the relative age of the data, NEXRAD weather data should not be used for short-range weather avoidance.



WARNING: The Garmin G1000, as installed in Cessna Nav III aircraft, has a very high degree of functional integrity. However, the pilot must recognize that providing monitoring and/or self-test capability for all conceivable system failures is not practical. Although unlikely, it may be possible for erroneous operation to occur without a fault indication shown by the G1000. It is thus the responsibility of the pilot to detect such an occurrence by means of cross-checking with all redundant or correlated information available in the cockpit.



WARNING: For safety reasons, G1000 operational procedures must be learned on the ground.



WARNING: The United States government operates the Global Positioning System and is solely responsible for its accuracy and maintenance. The GPS system is subject to changes which could affect the accuracy and performance of all GPS equipment. Portions of the Garmin G1000 utilize GPS as a precision electronic NAVigation AID (NAVAID). Therefore, as with all NAVAIDs, information presented by the G1000 can be misused or misinterpreted and, therefore, become unsafe.



WARNING: To reduce the risk of unsafe operation, carefully review and understand all aspects of the G1000 Pilot's Guide documentation. Thoroughly practice basic operation prior to actual use. During flight operations, carefully compare indications from the G1000 to all available navigation sources, including the information from other NAVAIDs, visual sightings, charts, etc. For safety purposes, always resolve any discrepancies before continuing navigation.



WARNING: The illustrations in this guide are only examples. Never use the G1000 to attempt to penetrate a thunderstorm. Both the FAA Advisory Circular, Subject: Thunderstorms, and the Airman's Information Manual (AIM) recommend avoiding "by at least 20 miles any thunderstorm identified as severe or giving an intense radar echo."



CAUTION: The GDU 1040 PFD/MFD displays use a lens coated with a special anti-reflective coating that is very sensitive to skin oils, waxes, and abrasive cleaners. **CLEANERS CONTAINING AMMONIA WILL HARM THE ANTI-REFLECTIVE COATING.** It is very important to clean the lens using a clean, lint-free cloth and an eyeglass lens cleaner that is specified as safe for anti-reflective coatings.



CAUTION: The Garmin G1000 does not contain any user-serviceable parts. Repairs should only be made by an authorized Garmin service center. Unauthorized repairs or modifications could void both the warranty and the pilot's authority to operate this device under FAA/FCC regulations.



NOTE: When using Stormscope, there are several atmospheric phenomena in addition to nearby thunderstorms that can cause isolated discharge points in the strike display mode. However, clusters of two or more discharge points in the strike display mode do indicate thunderstorm activity if these points reappear after the screen has been cleared.



NOTE: All visual depictions contained within this document, including screen images of the G1000 panel and displays, are subject to change and may not reflect the most current G1000 system. Depictions of equipment may differ slightly from the actual equipment.



NOTE: This device complies with part 15 of the FCC Rules. Operation is subject to the following two conditions: (1) this device may not cause harmful interference, and (2) this device must accept any interference received, including interference that may cause undesired operation.



NOTE: The GDU 1040 PFD/MFD may require a warm-up time of up to 30 minutes when exposed to -40°C for an extended period. A warm-up time of up to 15 minutes may be required when exposed to -30°C for an extended period.

Part Number	Change Summary
190-00384-03 (Rev. A)	Added XM Radio and XM Weather Added ADF capability Added DME capability Added BRG1/BRG2 pointers Added dual audio panel operation Added C172 parameters Changed Airspeed Trend Vector Changed Altitude Trend Vector Added Checklist capability Added Flight ID capability
190-00384-03 (Rev. B)	Updated system software numbers
190-00384-04 (Rev. A)	Reformatted manual to new format Added TAS capability
190-00384-04 (Rev. B)	Added DONE softkey, XM-INFORMATION Page, and XM-RADIO Page operation.
190-00384-05 (Rev. A)	Added explanation of EIS display behavior upon exceedances Added better explanation of Intercom System Isolation Added Stormscope operation upon loss of heading input Added TAWS-B Added CO Guardian Added new Fuel Totalizer Updated G1000 System Messages

Revision	Date of Revision	Affected Pages	Description
A	10/05	i through Index-4	Initial release

This page intentionally left blank.

SECTION 1: SYSTEM OVERVIEW	1-1	Auto-tuning on the MFD	4-4
1.1 PFD/MFD Controls	1-2	4.7 Transponder	4-4
1.2 PFD Softkeys	1-4	Mode Selection	4-4
1.3 MFD Softkeys	1-6	<i>Ground Mode (Automatic)</i>	4-4
1.4 MFD Page Groups	1-8	<i>Reply Status</i>	4-4
1.5 Backlighting	1-8	<i>Code Selection</i>	4-4
1.6 XM Radio - Automatic Muting	1-8	Flight ID Reporting	4-5
SECTION 2: FLIGHT INSTRUMENTS	2-1	SECTION 5: AUDIO PANEL	5-1
2.1 Airspeed Indicator	2-3	5.1 COM Radio Selection	5-2
Speed Indication	2-3	5.2 Marker Beacon Receiver	5-2
Speed Ranges	2-3	Marker Beacon Signal Sensitivity	5-2
Airspeed Trend Vector	2-3	5.3 Nav Radio Audio Selection	5-2
Vspeed References	2-3	5.4 Intercom System (ICS) Isolation	5-3
2.2 Attitude Indicator	2-3	5.5 Intercom Squelch Control	5-3
2.3 Altimeter	2-4	5.6 Digital Clearance Recorder with Playback	
Altitude Reference Bug.....	2-4	Capability	5-4
Altitude Trend Vector	2-4	SECTION 6: AUTOMATIC FLIGHT CONTROL	6-1
Barometric Setting Box.....	2-4	SECTION 7: NAVIGATION	7-1
2.4 Vertical Deviation/Glideslope Indicator	2-4	7.1 Navigation Map Page	7-1
2.5 Marker Beacon Annunciations	2-4	Select the MAP Page Group.....	7-1
2.6 Vertical Speed Indicator	2-5	7.2 Direct-to Navigation	7-1
2.7 Horizontal Situation Indicator (HSI)	2-5	Direct-to Navigation from the MFD.....	7-1
Course Pointer	2-6	Direct-to Navigation from the PFD	7-2
Course Deviation Indicator (CDI).....	2-6	7.3 Airport Information	7-3
Bearing Pointers and Information Windows.....	2-6	Select the Airport Information Page	7-3
DME Radio (optional).....	2-7	Enter a Waypoint Facility Name or City Location.....	7-3
Navigation Source.....	2-7	Access Runway Information.....	7-3
SECTION 3: ENGINE INDICATION SYSTEM (EIS)	3-1	Access Frequency Information.....	7-3
3.1 Engine Display	3-1	7.4 Intersection Information	7-4
3.2 Lean Engine Display	3-1	Select the Intersection Information Page	7-4
3.3 Engine System Display	3-2	Access Information on an Intersection	7-4
SECTION 4: NAV/COM AND TRANSPONDER	4-1	7.5 NDB Information	7-4
4.1 Radio Status Indications	4-3	Select the NDB Information Page.....	7-4
4.2 Volume	4-3	View Information on a Specific NDB	7-4
4.3 Automatic Squelch	4-3	7.6 VOR Information	7-5
4.4 Quickly Activating 121.500 MHz	4-3	Select the VOR Information Page	7-5
4.5 Optional NAV Radios	4-3	Access Information on a VOR:.....	7-5
DME Radio (optional).....	4-3	7.7 User Waypoint Information Page	7-5
ADF Radio (optional).....	4-3	7.8 Nearest Airports	7-5
4.6 Frequency Auto-tuning	4-4	Nearest Airport Information on the MFD	7-5
Auto-tuning on the PFD	4-4	Nearest Airports Information on the PFD.....	7-6

7.9 Nearest Intersections	7-6	8.13 Edit a Stored Flight Plan	8-5
Select the Nearest Intersections Page.....	7-6	8.14 Delete a Waypoint from the Flight Plan	8-5
View Information on the Nearest Intersection	7-7	8.15 Invert and activate a Stored Flight Plan	8-5
7.10 Nearest NDB	7-7	8.16 Copy a Flight Plan	8-6
Select the Nearest NDB Page.....	7-7	8.17 Delete a Flight Plan	8-6
Access Information on a Specific NDB.....	7-7	8.18 Graphical Flight Plan Creation	8-6
7.11 Nearest VOR	7-7	8.19 Trip Planning	8-6
Select the Nearest VOR Page	7-7	8.20 Vertical Navigation (VNAV) Page	8-7
View Information on the Nearest VOR.....	7-7	VNAV Page Menu OPTIONS.....	8-9
Select and Load a VOR Frequency	7-8	SECTION 9: PROCEDURES	9-1
7.12 Nearest User Waypoint	7-8	9.1 Arrivals and Departures	9-1
Select the Nearest User Waypoint Page.....	7-8	Load and Activate a Departure Procedure	9-1
Select a Nearest User Waypoint	7-8	Load and Activate an Arrival Procedure	9-1
7.13 Nearest Frequencies	7-8	9.2 Approaches	9-2
Select the Nearest Frequencies Page	7-8	Load and/or Activate an Approach Procedure	9-2
Select and Load the Nearest ARTCC, FSS, or Weather		Activate An Approach in the Active Flight Plan	9-3
Frequency	7-9	SECTION 10: HAZARD AVOIDANCE	10-1
7.14 Nearest Airspaces	7-9	10.1 Customizing the Hazard Displays on the	
Select the Nearest Airspaces Page.....	7-9	Navigation Map	10-1
Airspace Alerts Box	7-9	10.2 STORMSCOPE® (Optional)	10-1
View Additional Details for a Listed Airspace.....	7-9	Displaying Stormscope Lightning Data on the	
View and Quickly Load the Frequency for a		Navigation Map Page.....	10-1
Controlling Agency.....	7-9	Stormscope Page.....	10-2
SECTION 8: FLIGHT PLANNING	8-1	10.3 XM Weather (Service Optional)	10-3
8.1 User Defined Waypoints	8-1	Displaying METAR and TAF information on the	
Select the User WPT Information Page	8-1	Airport Information Page.....	10-3
Create a New User Waypoint.....	8-1	Displaying Weather on the Weather Data Link Page ...	10-4
Create User Waypoints from the Navigation		NEXRAD Limitations	10-4
Map Page	8-1	Map Panning Information – Weather Data Link Page .	10-5
Modify a User Waypoint	8-2	Weather Products & Symbols.....	10-5
Delete a User Waypoint	8-2	Weather Product Age	10-6
8.2 Viewing the Active Flight Plan	8-2	10.4 Traffic Information Service (TIS)	10-7
8.3 Activate a Stored Flight Plan	8-2	Displaying Traffic on the Traffic Map Page.....	10-7
8.4 Activate a Flight Plan Leg	8-2	Displaying Traffic on the Navigation Map	10-7
8.5 Stop Navigating a Flight Plan	8-3	TIS Audio Alert	10-7
8.6 Invert Active Flight Plan	8-3	10.5 Traffic Advisory System (TAS) (Optional)	10-8
8.7 Create a New Flight Plan	8-3	System Self Test.....	10-8
8.8 Load a Departure	8-4	Displaying Traffic on the Traffic Map Page.....	10-8
8.9 Load an Arrival	8-4	Displaying Traffic on the Navigation Map	10-9
8.10 Load an Approach	8-4		
8.11 Remove a Departure, Arrival, or Approach			
from a Flight Plan	8-5		
8.12 Store a Flight Plan	8-5		

10.6 Terrain And Obstacle Proximity 10-9
 Displaying Terrain and Obstacles on the Terrain Proximity Page 10-9
 Displaying Terrain and Obstacles on the Navigation Map..... 10-10

10.7 Terrain awareness & Warning system (TAWs) Display (Optional) 10-10
 Displaying Terrain on the TAWS Page 10-10
 Enable/Disable Aviation Data..... 10-12
 TAWS Inhibit 10-12
 Manual System Test..... 10-12
 Forward Looking Terrain Avoidance (FLTA)..... 10-12
 Reduced Required Terrain Clearance (RTC) and Reduced Required Obstacle Clearance (ROC) 10-12
 Imminent Terrain Impact (ITI) and Imminent Obstacle Impact (IOI)..... 10-12
 Premature Descent Alert (PDA) 10-13
 Excessive Descent Rate Alert (EDR) 10-14
 Negative Climb Rate After TakeoffAlert (NCR) 10-14
 “Five-Hundred” Aural Alert..... 10-14
 Displaying Terrain and Obstacles on the Navigation Map 10-14
 Pop-up Alerts 10-15
 TAWS Alerts Summary 10-16
 Alert Annunciations 10-17

SECTION 11: ABNORMAL OPERATION 11-1
11.1 Reversionary Mode 11-1
11.2 Abnormal COM Operation 11-2
11.3 Unusual Attitudes 11-2
11.4 Stormscope operation with loss of Heading Input..... 11-2

SECTION 12: ANNUNCIATIONS & ALERTS 12-1
12.1 Alert Level Definitions 12-2
12.2 NAV III Aircraft Alerts 12-3
 WARNING Alerts 12-3
 CAUTION Alerts 12-3
 CAUTION Alerts (T182, T206, and 206 with Prop De-Ice Only) 12-3
 Safe Operating Annunciation (T182, T206, and 206 with Prop De-Ice Only) 12-3
12.3 CO Guardian Messages 12-3
12.4 TAWS Alerts..... 12-4

12.5 G1000 System Annunciations 12-6
 Traffic Voice Alerts 12-6

12.6 G1000 System Message Advisories 12-8
 MFD & PFD Message Advisories..... 12-9
 Database Message Advisories 12-10
 GMA 1347 Message Advisories 12-11
 GIA 63 Message Advisories 12-11
 GEA 71 Message Advisories 12-13
 GTX 33 Message Advisories..... 12-14
 GRS 77 Message Advisories..... 12-14
 GMU 44 Message Advisories 12-15
 GDL 69 Message Advisories..... 12-15
 GDC 74A Message Advisories..... 12-15
 Miscellaneous Message Advisories..... 12-16

INDEX Index-1

This page intentionally left blank.

SECTION 1: SYSTEM OVERVIEW

The purpose of this Cockpit Reference Guide is to provide the pilot a resource with which to find operating instructions on the major features of the G1000 system more easily. **It is not intended to be a comprehensive operating guide.** Complete operating procedures for the complete system are found in the Garmin G1000 Pilot's Guide for the Cessna Nav III (190-00498-00).

This guide gives the pilot abbreviated operating instructions for the Primary Flight Display (PFD), Multi Function Display (MFD), and the GMA 1347 Audio Panel System.



NOTE: *The pilot should read and thoroughly understand the Cessna Pilot's Operating Handbook (POH) for limitations, procedures and operational information not contained in this Cockpit Reference Guide. The Cessna POH always takes precedence over the information found in this guide.*

1.1 PFD/MFD CONTROLS

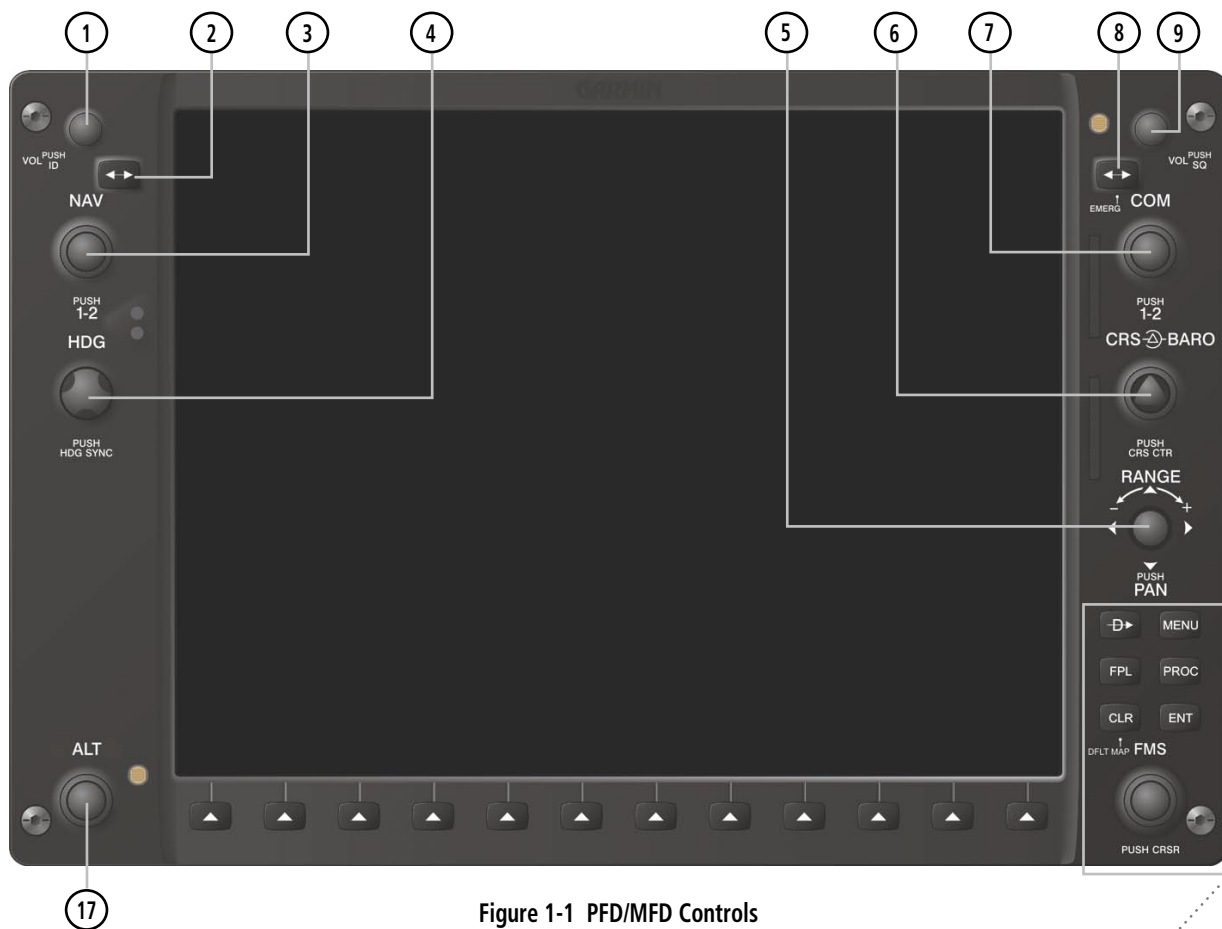
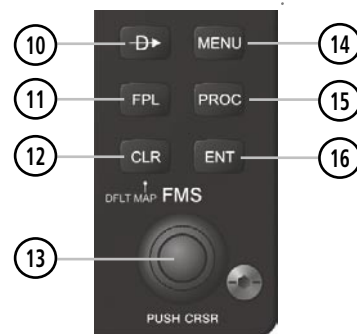

Figure 1-1 PFD/MFD Controls

- | | |
|----------------------------|---------------------------------|
| ① NAV VOL/ID Knob | ⑩ Direct-to Key |
| ② NAV Frequency Toggle Key | ⑪ Flight Plan Key |
| ③ NAV Knob | ⑫ Clear Key |
| ④ Heading Knob | ⑬ Flight Management System Knob |
| ⑤ Range Joystick | ⑭ Menu Key |
| ⑥ Course/Baro Knob | ⑮ Procedure Key |
| ⑦ COM Knob | ⑯ Enter Key |
| ⑧ COM Frequency Toggle Key | ⑰ Altitude Knob |
| ⑨ COM VOL/SQ Knob | |



(1) NAV VOL/ID Knob – Controls the NAV audio level. Press to toggle the Morse code identifier ON and OFF. Volume level is shown in the field as a percentage.

(2) NAV Frequency Toggle Key – Toggles the standby and active NAV frequencies.

(3) Dual NAV Knob – Tunes the MHz (large knob) and kHz (small knob) standby frequencies for the NAV receiver. Press to toggle the tuning cursor (light blue box) between the NAV1 and NAV2 fields.

(4) Heading Knob – Turn to manually select a heading on the HSI. When pressed, it synchronizes the heading bug with the compass lubber line.

(5) Joystick – Changes the map range when rotated. Activates the map pointer when pressed.

(6) CRS/BARO Knob – The **large** knob sets the altimeter barometric pressure and the **small** knob adjusts the course. The course is only adjustable when the HSI is in VOR1, VOR2, or OBS/SUSP mode. Pressing this knob centers the CDI on the currently selected VOR.

(7) Dual COM Knob – Tunes the MHz (large knob) and kHz (small knob) standby frequencies for the COM transceiver. Pressing this knob toggles the tuning cursor (light blue box) between the COM1 and COM2 fields.

(8) COM Frequency Toggle Key – Toggles the standby and active COM frequencies. Pressing and holding this key for two seconds automatically tunes the emergency frequency (121.5 MHz) in the active frequency field.

(9) COM VOL/SQ Knob – Controls COM audio level. Pressing this knob turns the COM automatic squelch ON and OFF. Audio volume level is shown in the field as a percentage.

(10) Direct-to Key – Allows the user to enter a destination waypoint and establish a direct course to the selected destination (specified by the identifier, chosen from the active route, or taken from the map cursor position).

(11) FPL Key – Displays the active Flight Plan Page for creating and editing the active flight plan, or for accessing stored flight plans.

(12) CLR Key (DFLT MAP) – Erases information, can-

cells an entry, or removes page menus. To display the Navigation Map Page immediately, press and hold **CLR** (MFD only).

(13) Dual FMS Knob – Used to select the page to be viewed (only on the MFD). The **large** knob selects a page group (MAP, WPT, AUX, NRST), while the **small** knob selects a specific page within the page group. Pressing the **small** knob turns the selection cursor ON and OFF. When the cursor is ON, data may be entered in the different windows using the **small** and **large** knobs. The **large** knob is used to move the cursor on the page, while the **small** knob is used to select individual characters for the highlighted cursor location. When the G1000 displays a list that is too long for the display screen, a scroll bar appears along the right side of the display, indicating the availability of additional items within the selected category. Press the **FMS/PUSH CRSR knob** to activate the cursor and turn the **large FMS** knob to scroll through the list.

(14) MENU Key – Displays a context-sensitive list of options. This list allows the user to access additional features, or to make setting changes that relate to certain pages.

(15) PROC Key – Selects approaches, departures and arrivals from the flight plan. If a flight plan is used, available procedures for the departure and/or arrival airport are automatically suggested. If a flight plan is not used, the desired airport and the desired procedure may be selected. This key selects IFR departure procedures (DPs), arrival procedures (STARs) and approaches (IAPs) from the database and loads them into the active flight plan.

(16) ENT Key – Accepts a menu selection or data entry. This key is used to approve an operation or complete data entry. It is also used to confirm selections and information entries.

(17) Dual ALT Knob – Sets the reference altitude in the box located above the Altimeter. The **large** knob selects the thousands, while the **small** knob selects the hundreds. Selected altitude provides an altitude setting to the altitude alerter function.

1.2 PFD SOFTKEYS

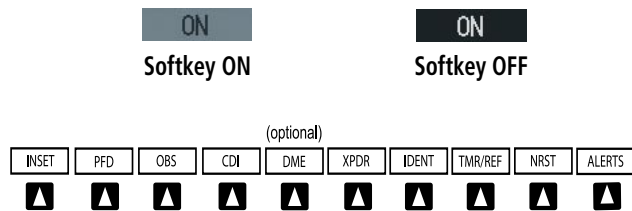

Figure 1-2 PFD Top Level Softkeys

INSET – Press to display the Inset Map in the lower left corner of the PFD.

OFF – Press to remove the Inset Map

DCLTR (3) – Press momentarily to select the desired amount of map detail. The declutter level appears adjacent to the **DCLTR** softkey.

- No declutter: All map features are visible
- Declutter – 1: Declutters land data
- Declutter – 2: Declutters land and SUA data
- Declutter – 3: Declutters large NAV data remaining (removes everything except the active flight plan)

TRAFFIC – Press to display TIS or TAS traffic on the inset map.

TOPO – Press to display topographical data (i.e., coastlines, terrain, rivers, lakes, etc.) and elevation scale on the inset map.

TERRAIN – Press to display terrain information on the inset map.

STRMSCP (optional) – Press to display the Stormscope lightning data on the inset map (within a 200 nm radius of the aircraft).

NEXRAD (optional) – Press to display NEXRAD precipitation data on the inset map.

XMLTNG (optional) – Press to display the XM Radio lightning data on the inset map.

BACK – Press to return to the previous level softkey configuration.

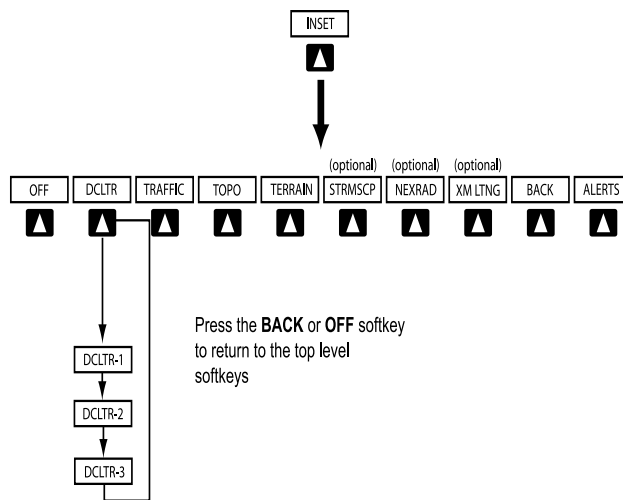

Figure 1-3 PFD Softkey Flow Chart – 1

PFD – Press to display the additional softkeys for additional configurations to the PFD.

METRIC – Press to display the current and reference altitudes in meters, in addition to feet. Pressing the metric softkey also changes the barometric setting to hectopascals.

DFLT5 – Press to reset default settings on the PFD.

DME (optional) – Press to display the DME information window.

BRG1 (bearing) – Press to cycle through the following Nav sources, making the pointer the indicator for the corresponding source and displaying the appropriate information.

NAVI – Displays NAV1 waypoint frequency or identifier and DME information in the BRG1 information window.

GPS – Displays GPS waypoint identifier and GPS distance information in the BRG1 information window.

ADF – Displays ADF in the BRG1 information window.

OFF – Removes the BRG1 information window.

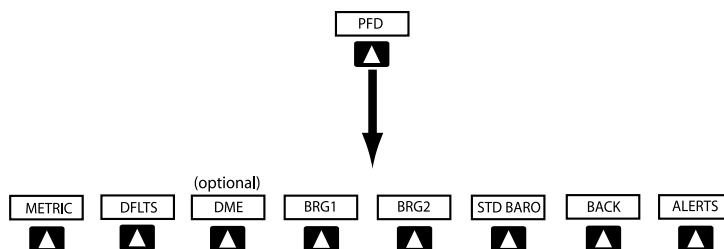

Press the **DFLTS** softkey to change the PFD metric values to standard

Press the **STD BARO** or **BACK** softkeys to return to the top level softkeys

Figure 1-4 PFD Softkey Flow Chart – 2

BRG2 (bearing) – Press to cycle through the following Nav sources, making the pointer the indicator for the corresponding source and displaying the appropriate information.

NAV2 – Displays NAV2 waypoint frequency or identifier and DME information in the BRG2 information window.

GPS – Displays GPS waypoint identifier and GPS distance information in the BRG2 information window.

ADF – Displays ADF in the BRG2 information window.

OFF – Removes the BRG2 information window.

STD BARO – Press to set the barometric pressure to 29.92 inches of mercury (1013 hPa by pressing the **METRIC** softkey).

BACK – Press to return to the previous level softkeys.

OBS – Press to select OBS mode on the CDI when navigating by GPS (only available with active leg).

CDI – Press to change navigation mode on the CDI between GPS, VOR1 and VOR2.

DME (optional) – Press to display the DME Tuning window.

XPDR – Press to display the transponder mode selection softkeys.

STBY – Press to select standby mode.

ON – Press to select mode A.

ALT – Press to select altitude reporting mode.

VFR – Press to automatically squawk 1200 (only in the U.S.A., refer to ICAO standards for VFR codes in other countries).

CODE – Press to display transponder code selection softkeys 0-7.

0 through 7 – Press numbers to enter code.

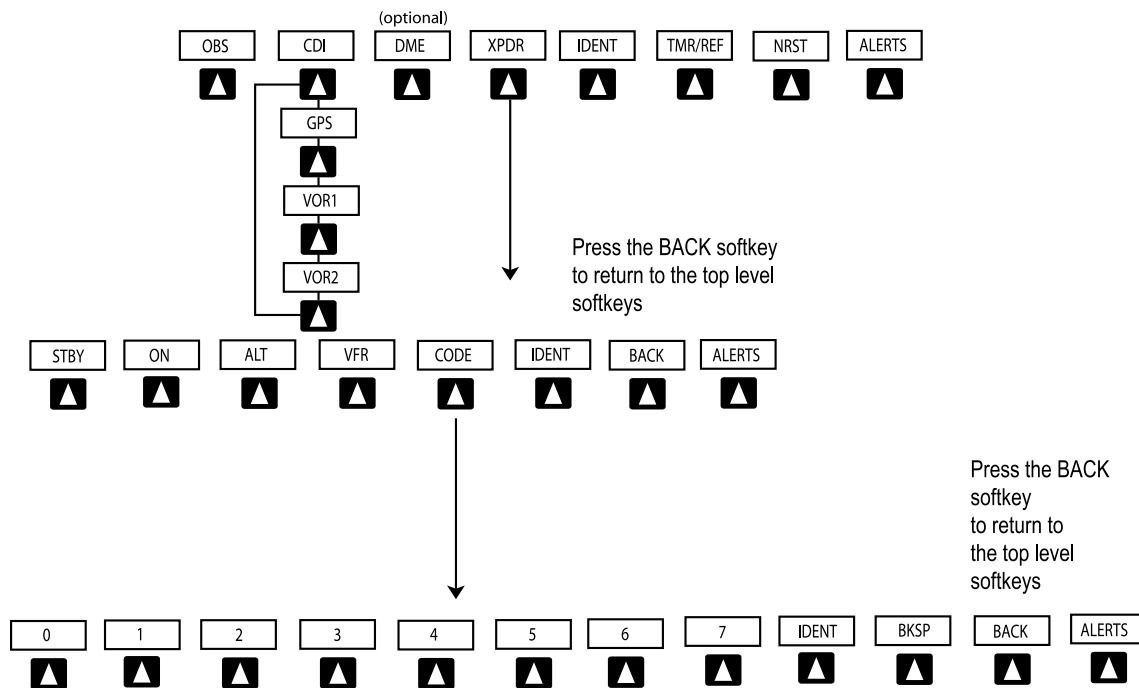

Figure 1-5 PFD Softkey Flow Chart – 3

IDENT – Press to provide special aircraft position identification to Air Traffic Control (ATC).

BKSP – Press to remove numbers entered one at a time.

BACK – Press to return to the previous level softkeys.

IDENT – Press to provide special aircraft position identification to Air Traffic Control (ATC).

BACK – Press to return to the previous level softkeys.

IDENT – Press to provide special aircraft position identification to Air Traffic Control (ATC).

TMR/REF – Press to display the Timer/References window.

NRST – Press to display the Nearest Airports window.

ALERTS – Press to display the Alerts window.

1.3 MFD SOFTKEYS

ENGINE – Pressing this softkey makes available the **LEAN** and **SYSTEM** softkeys which in turn access the Lean Page and the System Page, respectively.

MAP – Pressing this softkey enables the following softkeys:

TRAFFIC – Pressing this softkey displays/removes Traffic on the Navigation Map.

TOPO – Pressing this softkey displays or removes topographic information on the Navigation Map.

TERRAIN – Pressing this softkey displays/removes terrain and obstacle data on the Navigation Map.

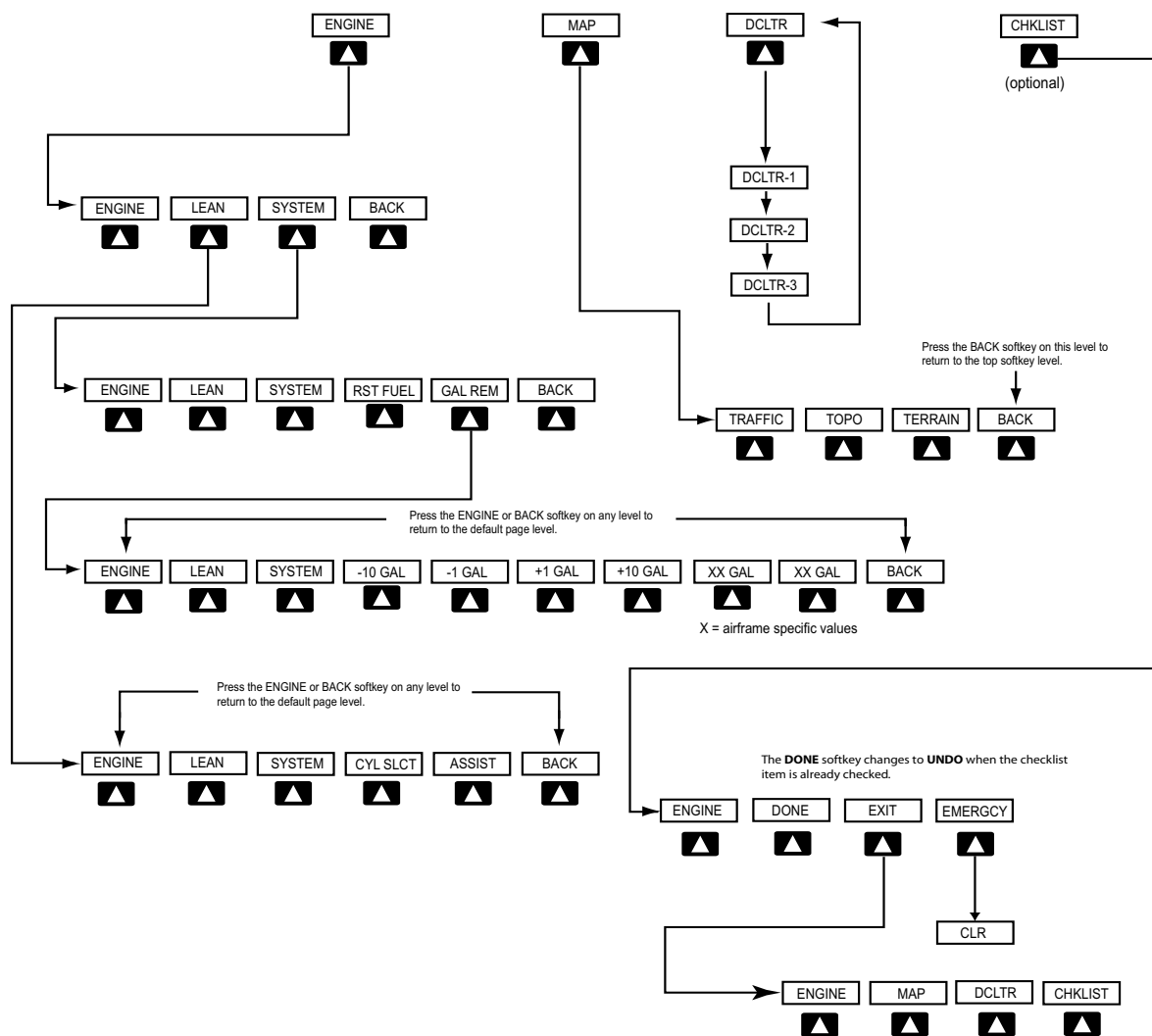

Figure 1-6 MFD Softkeys

STRMSCP (optional) – Pressing this softkey displays/removes Stormscope lightning data on the Navigation Map.

NEXRAD (optional) – Pressing this softkey displays/removes precipitation data on the Navigation Map.

XM LTNG (optional) – Pressing this softkey displays/removes XM Radio lightning data on the Navigation Map.

BACK – Pressing this softkey displays the ENGINE and MAP top level softkeys.

DCLTR (declutter) – Pressing this softkey removes map information in three levels.

CHKLIST (checklist)(optional) – Pressing the **CHKLIST** softkey displays the Checklist Page.

1.4 MFD PAGE GROUPS

1. Turn the **large FMS** knob until the desired page group is selected.
2. Turn the **small FMS** knob to select pages within the group. See Figure 1-7.

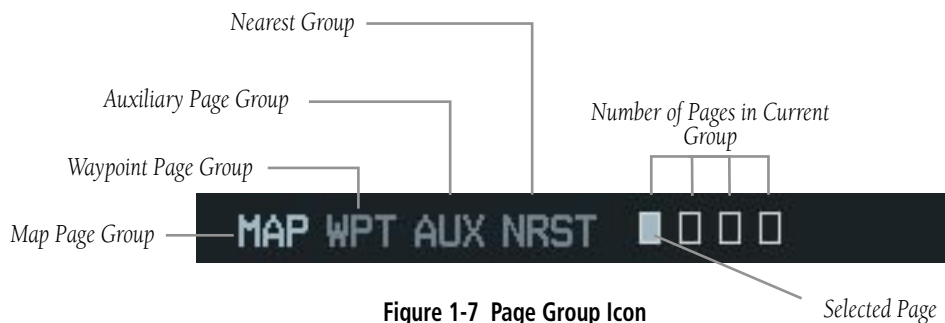

Figure 1-7 Page Group Icon

1.5 BACKLIGHTING

To manually adjust the backlight for the PFD and MFD:

1. Press the **MENU** key on the PFD to display the PFD Setup Menu window.
2. Press the **small FMS** knob to activate the cursor. 'PFD DSPL > AUTO' is now highlighted.
3. Turn the **small FMS** knob to display the selection window.
4. Turn the **FMS** knob to select 'MANUAL', then press the **ENT** key.
5. With the intensity value now highlighted, turn the **small FMS** knob to select the desired backlighting.
6. Turn the **large FMS** knob to highlight 'MFD DSPL > AUTO' and repeat steps 3 through 5.

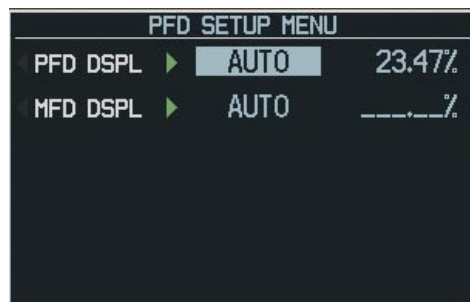

Figure 1-8 PFD Setup Menu Window

1.6 XM RADIO - AUTOMATIC MUTING

XM Radio audio will be automatically muted when the aircraft groundspeed exceeds approximately 30 kts **and** the airspeed is less than approximately 80 kts. The audio must be manually unmuted once the aircraft is outside the applicable speed range. Refer to the G1000 Optional Equipment section of the pilot's guide.

SECTION 2: FLIGHT INSTRUMENTS

The following discussions pertain to the Primary Flight Display, unless otherwise indicated.

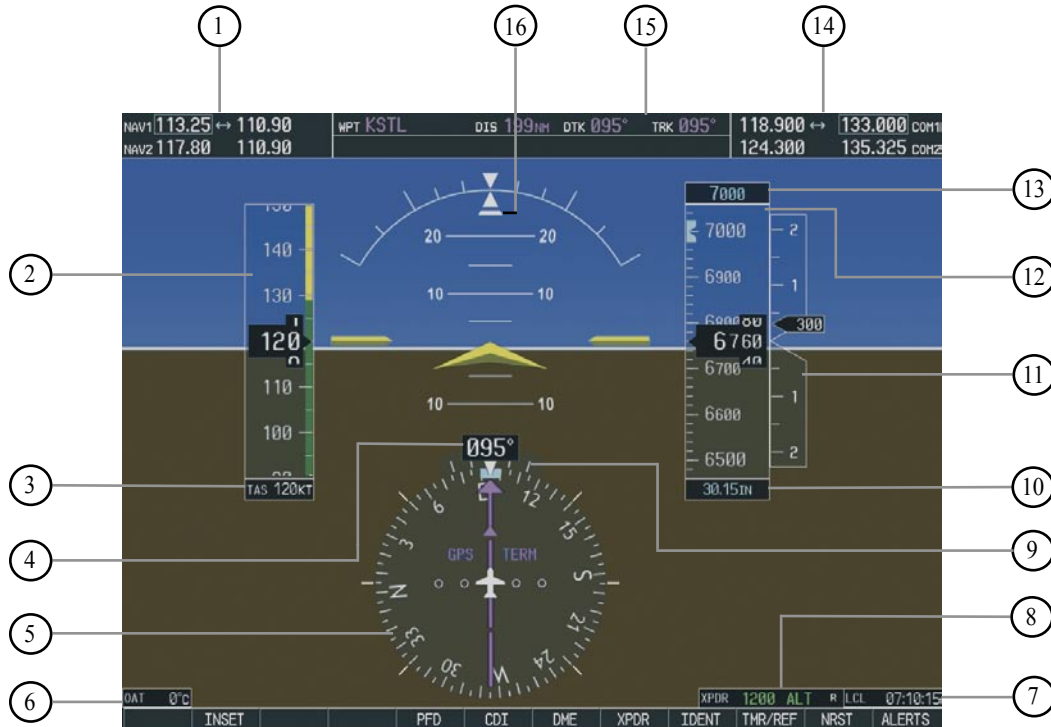

- | | |
|----------------------------------|----------------------------|
| ① NAV Frequency Window | ⑨ Turn Rate Indicator |
| ② Airspeed Indicator | ⑩ Barometric Setting Box |
| ③ True Airspeed Box | ⑪ Vertical Speed Indicator |
| ④ Heading Box | ⑫ Altimeter |
| ⑤ Horizontal Situation Indicator | ⑬ Altitude Reference Box |
| ⑥ Outside Air Temperature Box | ⑭ COM Frequency Window |
| ⑦ System Time Box | ⑮ Navigation Status Bar |
| ⑧ Transponder Status Bar | ⑯ Slip/Skid Indicator |

Figure 2-1 Default PFD Information

SECTION 2 FLIGHT INSTRUMENTS



- ① Traffic Annunciation
- ② Selected Heading Box
- ③ Inset Map
- ④ BRG1 Information Window
- ⑤ DME Information Window
- ⑥ BRG2 Information Window
- ⑦ Alerts Window
- ⑧ Selected Course Box
- ⑨ Annunciation Window
- ⑩ Vertical Deviation/Glideslope Indicator
- ⑪ Marker Beacon Annunciation

Figure 2-2 Additional PFD Information



Figure 2-3 PFD Navigation Status Window (default)

2.1 AIRSPEED INDICATOR

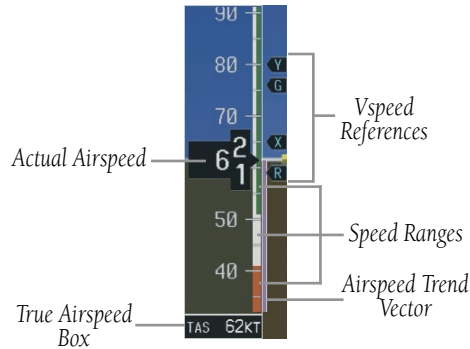

Figure 2-4 Airspeed Indicator

Speed Indication

The indicated airspeed is displayed inside the black pointer. The pointer will become red upon reaching Vne.



Figure 2-5 Red Pointer at Vne

Speed Ranges

The color coded speed range strip denotes flaps operating range, normal operating range, and never exceed speed (Vne). A red range is also present for low speed awareness. Refer to the Pilot's Operating Handbook (POH) for airspeed limitations and indicator markings.

Airspeed Trend Vector

The end of the trend vector displays approximately what the airspeed will be in 6 seconds if the current rate of acceleration/deceleration is maintained.

Vspeed References

Vspeed References are turned on or off in the Timer/References window. Press the **TMR/REF** softkey to display the window. When active (**ON**), the Vspeeds are displayed at their respective locations to the right of the airspeed scale. To activate the Vspeed References, display the Timer/Reference window and turn the **large FMS** knob to place the cursor in the ON/OFF field. Turn the **small FMS** knob to select **ON** or **OFF**.

2.2 ATTITUDE INDICATOR

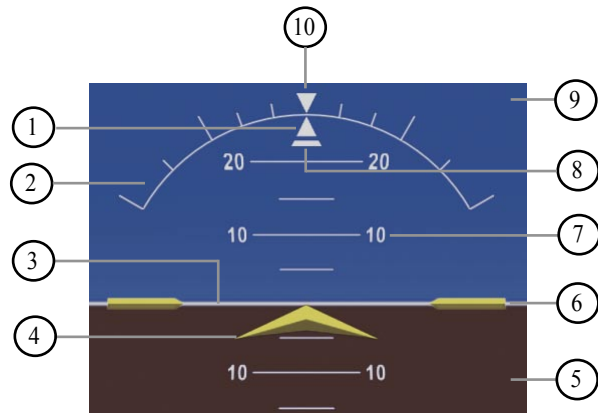

- ① Roll Pointer
- ② Roll Scale
- ③ Horizon Line
- ④ Aircraft Symbol
- ⑤ Land Representation
- ⑥ Aircraft Wing Tips
- ⑦ Pitch Scale
- ⑧ Slip/Skid Indicator
- ⑨ Sky Representation
- ⑩ Roll Index

Figure 2-6 Attitude Indicator

The Slip/Skid Indicator is located under the roll pointer and moves laterally away from the pointer to indicate lateral acceleration. One Slip/Skid indicator displacement is equal to one ball displacement when compared to a traditional slip/skid indicator.

2.3 ALTIMETER

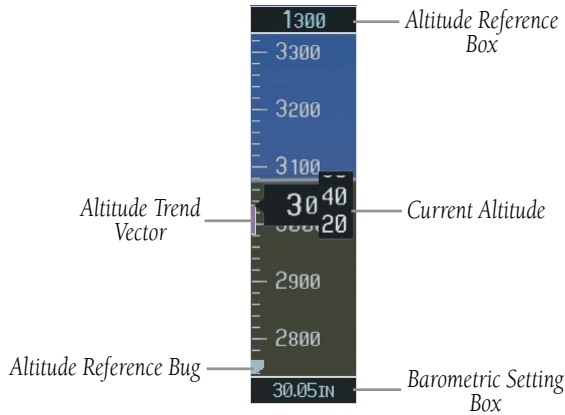

Figure 2-7 Altimeter

Altitude Reference Bug

The Altitude Reference Bug can be set to any desired altitude. The bug acts as a visual reference to indicate the desired altitude is approaching.

To set the altitude reference bug:

1. Turn the **ALT** knobs to set the altitude reference bug. The **small ALT** knob sets the hundreds and the **large ALT** knob sets the thousands. This altitude also appears in the altitude reference box above the altimeter.

Altitude Trend Vector

The end of the trend vector displays approximately what the altitude will be in 6 seconds if the current rate of vertical speed is maintained.

Barometric Setting Box

To set barometric pressure, turn the **BARO** knob to select the desired setting.

2.4 VERTICAL DEVIATION/GLIDESLOPE INDICATOR

The Vertical Deviation/Glideslope Indicator appears when an ILS is tuned in the active NAV field.

2.5 MARKER BEACON ANNUNCIATIONS

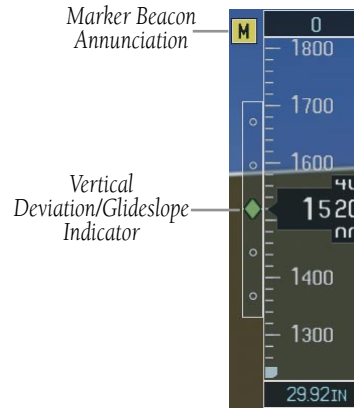

Figure 2-8 Marker Beacon and Vertical Deviation

2.6 VERTICAL SPEED INDICATOR

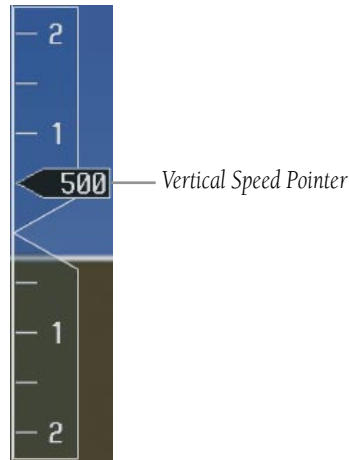
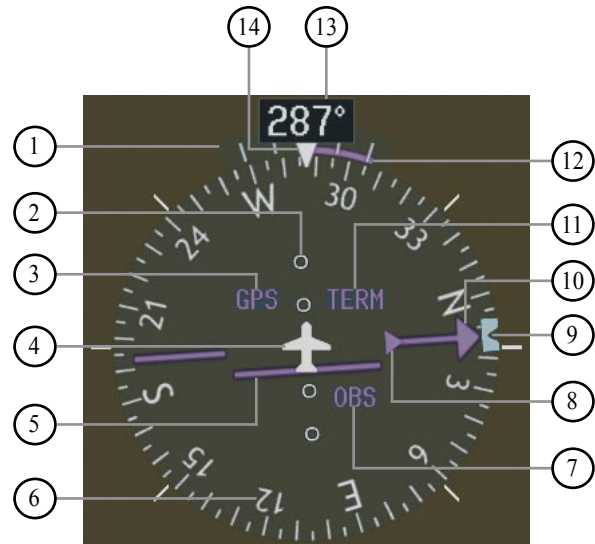

Figure 2-9 Vertical Speed Indicator

The actual vertical speed is displayed inside the pointer.

2.7 HORIZONTAL SITUATION INDICATOR (HSI)

The HSI compass can be displayed as a 360° rose or 140° arc by pressing the **PFD** softkey, followed by the **360 HSI** or the **ARC HSI** softkey.



- ① Turn Rate Indicator
- ② Lateral Deviation Scale
- ③ Navigation Source
- ④ Aircraft Symbol
- ⑤ Course Deviation Indicator
- ⑥ Rotating Compass Rose
- ⑦ OBS Mode
- ⑧ TO/FROM Indicator
- ⑨ Heading Bug
- ⑩ Course Pointer
- ⑪ Flight Phase
- ⑫ Turn Rate and Heading Trend Vector
- ⑬ Heading
- ⑭ Lubber Line

Figure 2-10 Horizontal Situation Indicator

Turn Rate Indicator and Heading Trend Vector

Each tick mark is at 9 (half standard rate tick mark) and 18 (standard rate tick mark) degrees to the left and right of the lubber line. A wide magenta line displays the current turn rate, up to 24 degrees. A magenta arrow-head appears at 25 degrees. This trend vector provides the pilot with a prediction of what the heading will be in 6 seconds at the present turn rate.

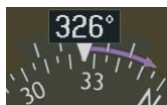

Figure 2-11 Turn Rate Indicator and Heading Trend Vector

Course Pointer

The course pointer is a single line arrow (GPS, VOR1 and LOC1) or double line arrow (VOR2 and LOC2) which points in the direction of the set course.



Figure 2-12 Course Pointer

Course Deviation Indicator (CDI)

The CDI scale automatically adjusts to the current phase of flight (enroute 5.0 nm, terminal area 1.0 nm, or approach 0.3 nm). Scaling may be selected manually from the MFD System Setup Page. See the MFD section of the pilot's guide for more details.

Bearing Pointers and Information Windows

Pressing the **PFD** softkey provides access to the **BRG1**

and **BRG2** softkeys. The BRG1 pointer is a single line pointer. The BRG2 pointer is a double line pointer. Press the **BRG1** or **BRG2** softkey to cycle through selecting NAV1/2, GPS, or ADF for display using the corresponding pointer.

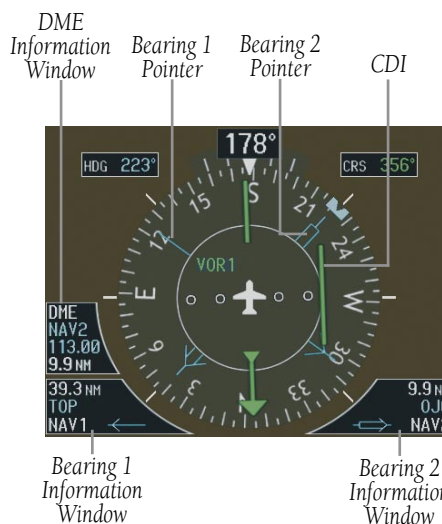

Figure 2-13 HSI with Bearing Information

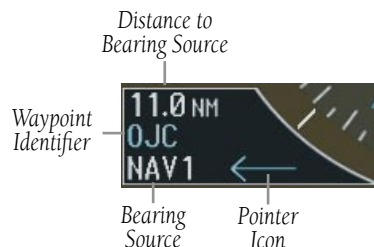

Figure 2-14 BRG1 Information Window

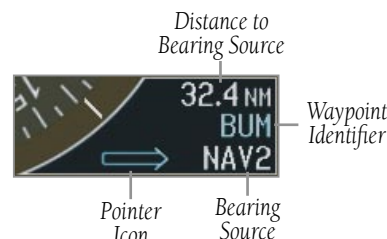

Figure 2-15 BRG2 Information Window

DME (optional)

To display the DME Information Window, press the **PF D** softkey followed by the **DME** softkey.



Figure 2-16 DME Information Window

Navigation Source

To change between CDI navigation sources:

1. Press the **CDI** softkey to change from GPS to VOR1/LOC1.
2. Press the **CDI** softkey again to change from VOR1/LOC1 to VOR2/LOC2.
3. Press the **CDI** softkey a third time to return to GPS.

When using GPS as the navigation source, the following may appear:

- **INTEG** – RAIM is not available
- **WARN** – GPS detects a position error
- **SUSP** – Displayed when in OBS Mode indicating GPS navigation is suspended.

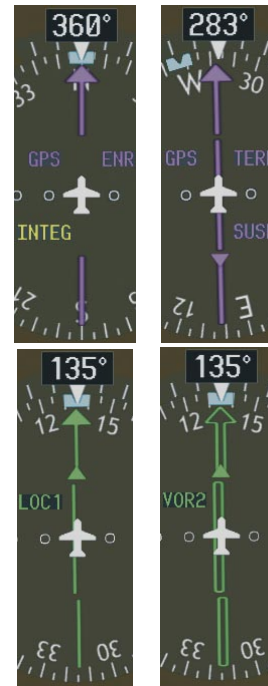

Figure 2-17 GPS INTEG, GPS SUSP, LOC1 and VOR2

To enable/disable OBS mode while navigating with GPS:

1. Press the **OBS** softkey to select OBS Mode.
2. Turn the **CRS** knob to select the desired course TO/FROM the waypoint.
3. Press the **OBS** softkey again to return to normal operation.



NOTE: The **OBS** softkey is only displayed when navigating an active leg.

This page intentionally left blank.

SECTION 3: ENGINE INDICATION SYSTEM (EIS)

3.1 ENGINE DISPLAY

In all cases green indicates normal operation, yellow indicates caution, and red indicates warning.

Pressing the **ENGINE** softkey makes available the **LEAN** and **SYSTEM** softkeys which in turn provide access to the Lean Page and the System Page, respectively.

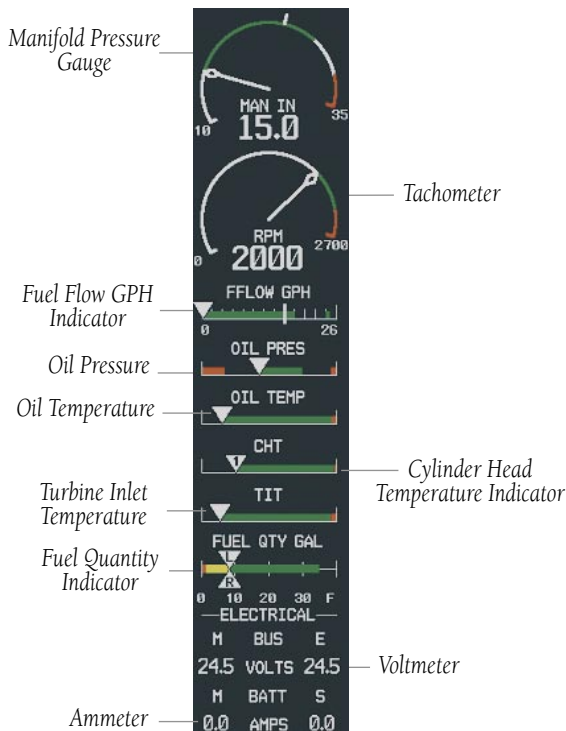

Figure 3-1 Default Engine Page (T182T Shown)

3.2 LEAN ENGINE DISPLAY

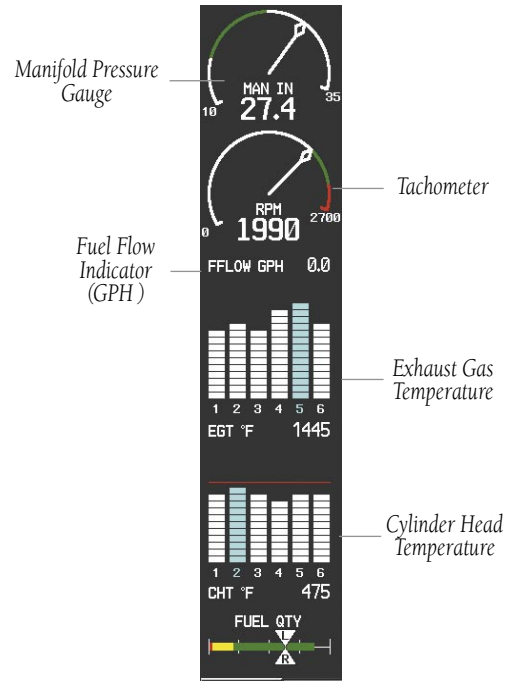

Figure 3-2 LEAN Engine Page (182T Shown)

Press the **CYL SLCT** softkey to select the desired cylinder for monitoring.

When a cylinder enters the warning or caution range, the **CYL SLCT** softkey is disabled until the temperature returns to normal. The **CYL SLCT** softkey is also disabled when the **ASSIST** softkey is pressed.

Pressing the **ASSIST** softkey causes the first cylinder that peaks to become highlighted and information for that cylinder to be displayed.

With the exception of the 172 CHT, any exceedance of default Engine Page parameters, while viewing the Lean Engine Page, will cause the display to automatically switch back to the default Engine Page.

3.3 ENGINE SYSTEM DISPLAY

Press the **RST FUEL** (Reset Fuel) softkey to reset the amount of fuel used and gallons remaining to zero. Press the **GAL REM** (Gallons Remaining) softkey to display the quantity adjustment softkeys. The **-10 GAL**, **-1 GAL**, **+1 GAL**, **+10 GAL** softkeys may be used to increase or decrease the remaining fuel quantity by the amount denoted by the softkey. Two additional adjustment softkeys are displayed that are airframe specific.

172 - **35 GAL** (filler neck tab) and **53 GAL** (full)

182, T182, 206, T206 - **64 GAL** (filler neck tab) and **87 GAL** (full)

Press these softkeys to enter that amount as gallons remaining.



NOTE: Fuel calculations do not use the aircraft fuel quantity indicators, and are calculated from the last time the fuel was reset.

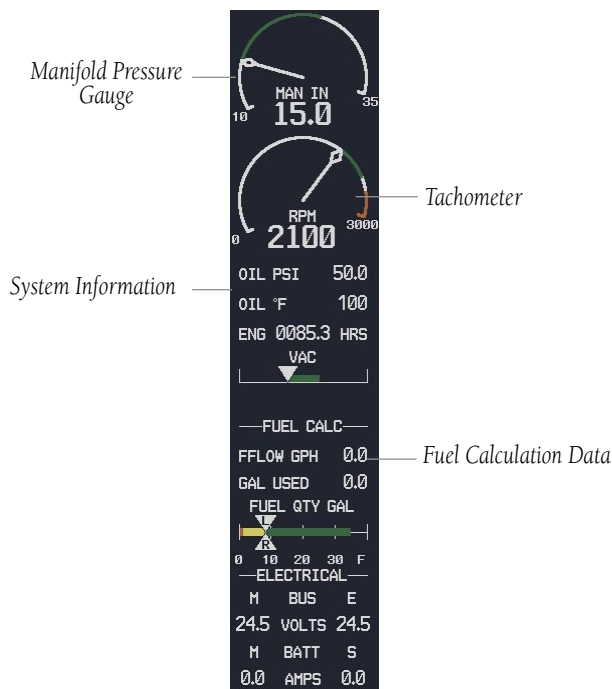

Figure 3-3 SYSTEM Engine Page (206H Shown)

With the exception of the 172 CHT, any exceedance of default Engine Page parameters while viewing the System Engine Page, will cause the display to automatically switch back to the default Engine Page.

SECTION 4: NAV/COM AND TRANSPONDER

The Nav/Com controls and frequency windows are located on the Primary Flight Display and the Multi-Function Display in the same locations.



Figure 4-1 G1000 VHF NAV/COM Interface (PFD)

DME Tuning Window

SECTION 4 – NAV/COM & TRANSPONDER

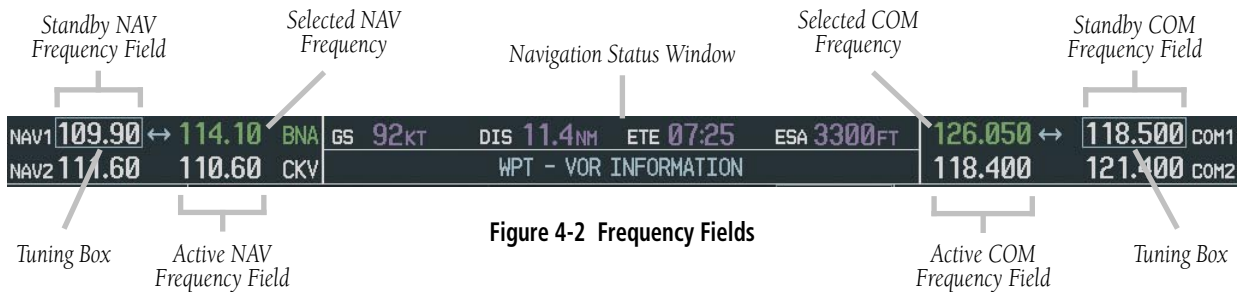

Figure 4-3 Frequency Toggle Arrow and Tuning Box

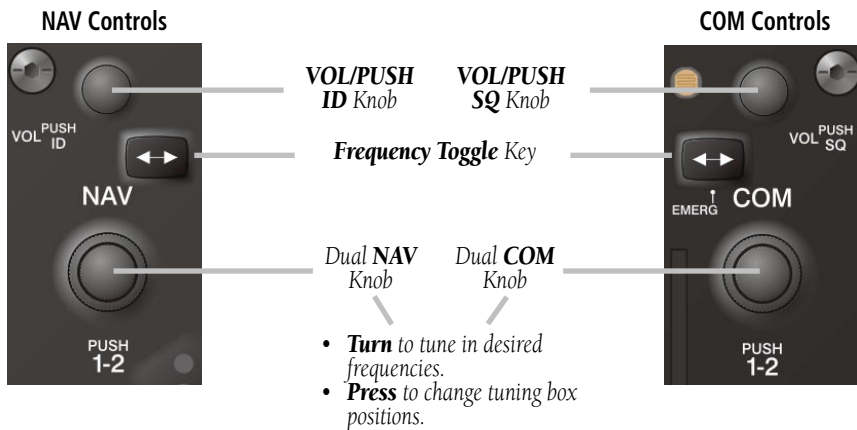

Figure 4-4 NAV/COM Controls

4.1 RADIO STATUS INDICATIONS

- **TX** – When a COM radio is keyed, a white **TX** indication appears to the right of the corresponding COM frequency.
- **ID** – When the Morse code identifier is ON for a NAV radio, a white **ID** indication appears to the left of the corresponding active NAV frequency. The Morse code identifier can be heard if the corresponding NAV radio is selected on the audio panel.

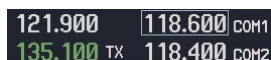

Figure 4-5 Radio Status Indications

4.2 VOLUME

'VOLUME' is displayed in place of the associated radio name (i.e., 'COM1' or 'NAV2') for two seconds after the volume level is last changed.



Figure 4-6 COM Volume Level

4.3 AUTOMATIC SQUELCH

Automatic squelch can be disabled for a COM radio by pressing the **COM** knob to select the desired COM sub-window, then by pressing the **VOL/PUSH SQ** knob.

4.4 QUICKLY ACTIVATING 121.500 MHZ

Pressing and holding the **COM Frequency Toggle** key for approximately two (2) seconds automatically tunes the selected COM radio to the emergency frequency.

4.5 OPTIONAL NAV RADIOS

DME Radio (optional)

The Tuning window is displayed by pressing the **DME** softkey.



Figure 4-7 Radio Tuning Window

To change the DME tuning source:

1. From the Tuning window, turn the **large FMS** knob to highlight the DME source field.
2. Turn the **small FMS** knob to display the selection window. Turn the **FMS** knob to select the desired mode and press the **ENT** key.



Figure 4-8 DME Selection Window

ADF Radio (optional)

The G1000 does not support tuning of the ADF in Nav III aircraft. ADF tuning is accomplished through the Bendix/King KR 87 ADF Radio. ADF volume must also be adjusted through the KR 87.

4.6 FREQUENCY AUTO-TUNING

Auto-tuning on the PFD



Figure 4-9 Nearest Airports Window (PFD)

1. Press the **NRST** softkey to display the Nearest Airports Window.
2. Turn either **FMS** knob to highlight the desired frequency.
3. Press the **ENT** key to place the frequency in the standby field of the active COM.
4. Press the **Frequency Toggle** key to place the frequency in the active field.

NAV frequencies are entered automatically in the NAV window upon approach loading or approach activation.

Auto-tuning on the MFD

Auto-tuning on the MFD is done in much the same way as on the PFD. Use the **FMS** knobs to select the desired frequency on any of the information pages. Pressing the **ENT** key then loads the selected frequency into the standby frequency window of the appropriate radio.

4.7 TRANSPONDER

Mode Selection

The **STBY**, **ON** and **ALT** softkeys can be accessed by pressing the **XPDR** softkey.

Ground Mode (Automatic)

GND is displayed when the aircraft is on the ground.

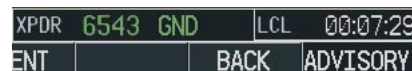

Figure 4-10 Ground Mode

Reply Status

When the transponder sends replies to interrogations, an “R” indication appears momentarily in the reply status field.

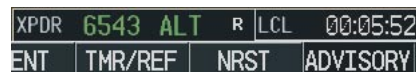

Figure 4-11 Reply Indication

Code Selection

1. Press the **XPDR** softkey to display the transponder Mode Selection softkeys.
2. Press the **CODE** softkey to display the transponder Code Selection softkeys, which includes the digit softkeys.
3. Press the appropriate digit softkeys to enter the code in the four-digit code field of the Transponder Status bar. Five seconds after the fourth digit has been entered, the transponder code becomes activated.

When entering a code, press the **BKSP** softkey as needed to back up and change code digits.

Following is a list of important codes:

- 1200 – VFR code in the U.S. (please refer to the ICAO standards for VFR codes in other countries).
- 7000 – VFR code commonly used in Europe (please refer to the ICAO standards).
- 7500 – Hijack code.
- 7600 – Loss of communication code.
- 7700 – Emergency code.
- 7777 – Military interceptor operations code (NEVER ENTER THIS CODE).
- 0000 – Code for military use (in the U.S.).

Flight ID Reporting

If so configured, the Flight ID may be entered in the Timer/Reference window. If configuration is set to “SAME AS TAIL” the aircraft tail number will always be displayed.

REFERENCES			
TIMER	00:00:00	UP	START?
GLIDE	76KT	◀	ON
V _r	59KT	◀	ON
V _x	65KT	◀	ON
V _y	80KT	◀	ON
FLIGHT ID	N59GA — Flight ID		

Figure 4-12 Timer/References Window

This page intentionally left blank.

SECTION 5: AUDIO PANEL

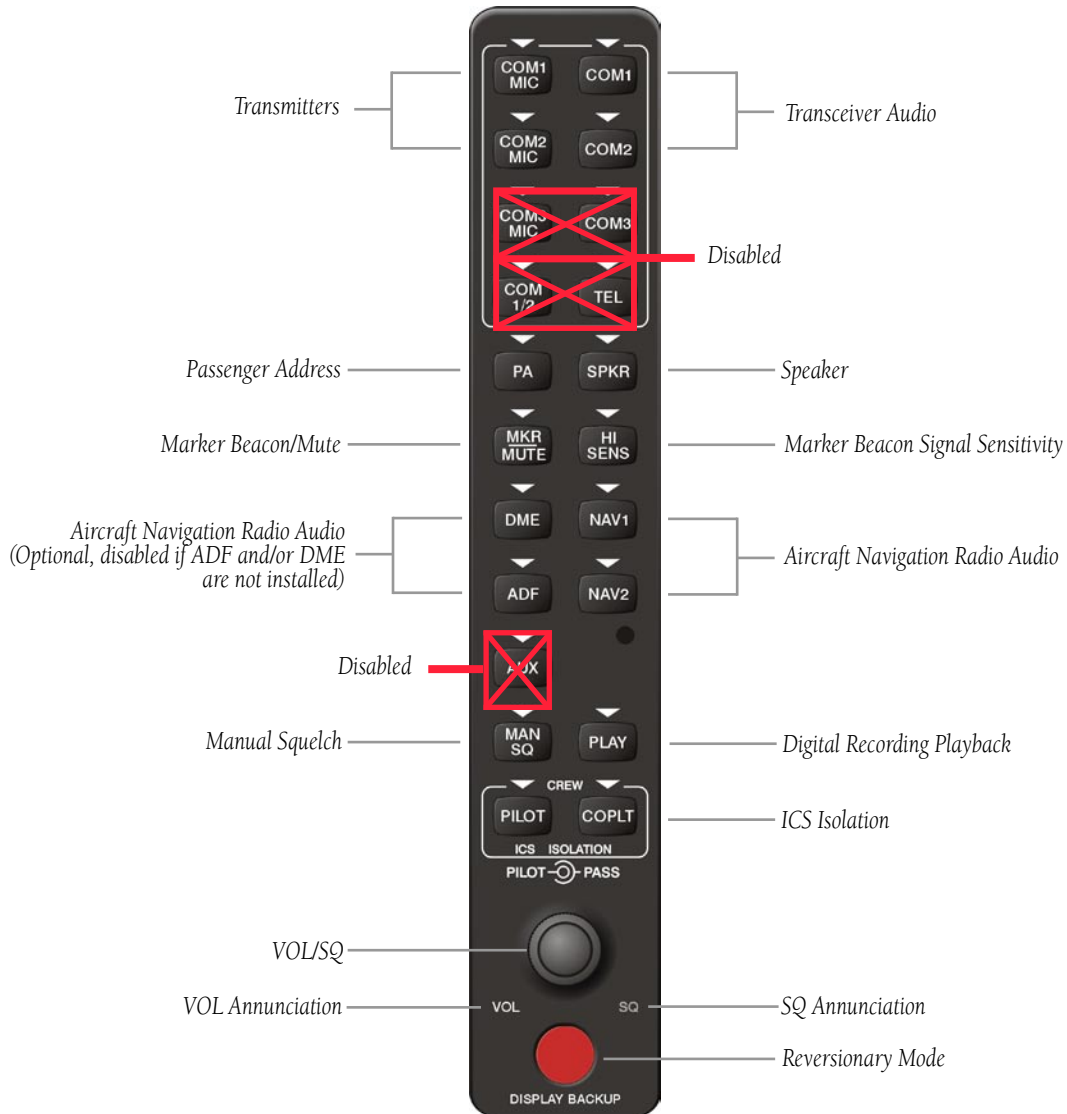

Figure 5-1 Front Panel Controls

5.1 COM RADIO SELECTION

Pressing the **COM1 MIC** or **COM2 MIC** key selects the active transmitter (i.e., microphone). The associated receiver audio (**COM1** or **COM2**) also becomes selected when the COM MIC key is pressed.

To prevent deselecting the desired received audio when pressing another COM MIC key, press the already selected **COM1** or **COM2** key before pressing the other COM MIC key.



Figure 5-2 Transceivers

5.2 MARKER BEACON RECEIVER

The marker beacon receiver is always ON. Figure 5-3 shows the marker beacon annunciators on the PFD

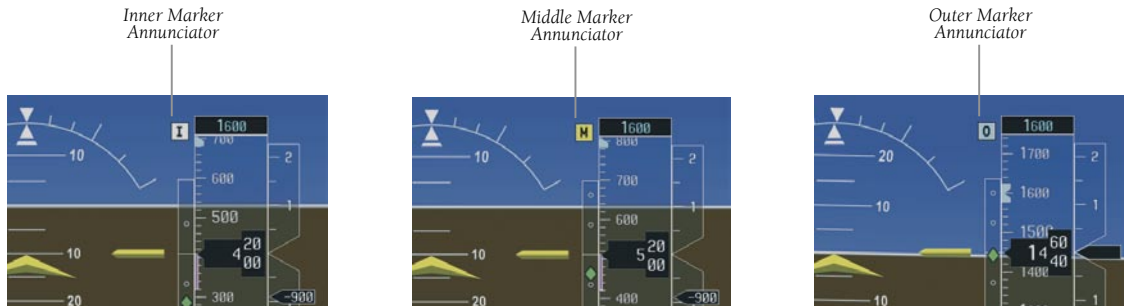

Figure 5-3 Marker Beacon Signal Indicator Lights on the PFD

When the **MKR/MUTE** key is pressed, the key annunciator is lit and the audio tone can be heard over the speaker or headsets during marker reception.

When the tone is active, pressing the **MKR/MUTE** key mutes the audio but does not affect the annunciator. The audio returns when the next marker signal is received.

Marker Beacon Signal Sensitivity

The **HI SENS** key can be pressed for increased marker beacon signal sensitivity.



Figure 5-4 Marker Beacon

5.3 NAV RADIO AUDIO SELECTION

Pressing **DME**, **ADF**, **NAV1**, or **NAV2** selects and deselects the audio source and activates the annunciator. Selected audio can be heard over the headset and the speakers. These four keys can be selected individually or together.



Figure 5-5 Navigation Radios

5.4 INTERCOM SYSTEM (ICS) ISOLATION

Press the **PILOT** and/or **COPLT** key to select who is isolated from hearing the Nav/Com radios and music. Selection scenarios are addressed in Table 5-1.



Figure 5-6 ICS Isolation

5.5 INTERCOM SQUELCH CONTROL

Select manual squelch for intercom audio by pressing the **MAN SQ** key to light the annunciator.

Pressing the **small VOL/SQ** knob now toggles between volume and squelch adjustment by lighting **VOL** or **SQ** respectively.



Figure 5-7 Volume/Squelch Control

Mode	PILOT KEY ANNUNCIATOR	COPLT KEY ANNUNCIATOR	Pilot Hears	Copilot Hears	Passenger Hears
ALL	OFF	OFF	Selected radios; pilot; copilot; passengers; MUSIC 1	Selected radios; pilot; copilot; passengers; MUSIC 1	Selected radios; pilot; copilot; passengers; MUSIC 2
PILOT	ON	OFF	Selected radios; pilot	Copilot; passengers; MUSIC 1	Copilot; passengers; MUSIC 2
COPILOT	OFF	ON	Selected radios; pilot; passengers; MUSIC 1	Copilot	Selected radios; pilot; passengers; MUSIC 2
CREW	ON	ON	Selected radios; pilot; copilot	Selected radios; pilot; copilot	Passengers; MUSIC 2

Table 5-1 ICS Isolation Modes

5.6 DIGITAL CLEARANCE RECORDER WITH PLAYBACK CAPABILITY

Each reception of primary active COM audio is automatically recorded in a memory block. When the next transmission is received, it is recorded in the next memory block, and so on. Once the 2.5 minutes of recording time has been reached, the recorder begins recording over the stored memory blocks, starting from the oldest block. Powering off the unit automatically clears all recorded blocks.



Figure 5-8 Playback

- Pressing **PLAY** once plays back the latest recorded memory block, then returns to normal operation.
- Pressing **PLAY** during playback of a memory block halts the playback of this block and plays back the preceding recorded block. The **PLAY** key can be used to backtrack through the recorded memory blocks to reach and play back any desired block. Pressing the **MKR/MUTE** key during playback halts playback and returns the recorder/playback to normal operation.

If a COM input signal is detected during playback, playback is halted and the new COM input signal is recorded as the latest block.

SECTION 6: AUTOMATIC FLIGHT CONTROL

Refer to the pilot's guide for the installed autopilot system.

This page intentionally left blank.

SECTION 7: NAVIGATION

The following discussions pertain to the Multi-function Display, unless otherwise indicated.

7.1 NAVIGATION MAP PAGE

Select the MAP Page Group

1. Turn the **large FMS** knob until MAP is highlighted in the page group window in the lower right of the MFD display.
2. Turn the **small FMS** knob to select the first MAP page (indicated by a solid rectangular icon).
3. Press the **MAP** softkey to display softkeys for the available information which may be displayed on the map.



WARNING: The map display should only be used for situational awareness. Any map display indication should be compared with approved navigation sources.

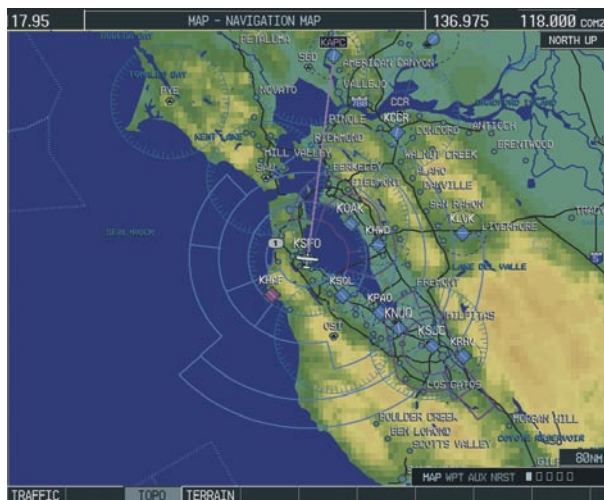

Figure 7-1 Navigation Map Page

7.2 DIRECT-TO NAVIGATION

Direct-to Navigation from the MFD

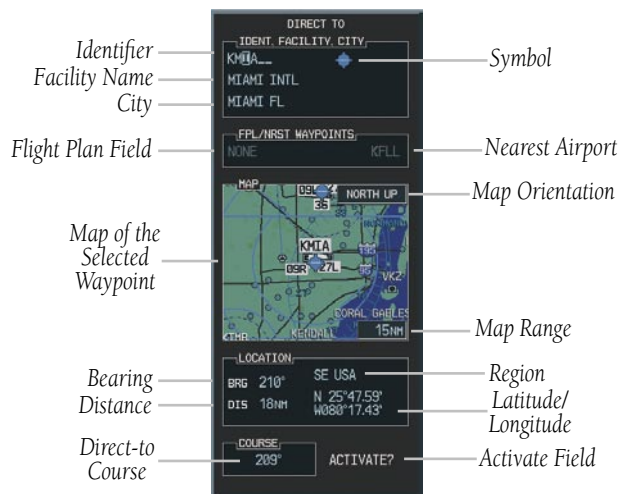

Figure 7-2 MFD Direct-to Window

To enter a Direct-to destination:

1. Press the **Direct-to** (D➤) key.
2. Turn the **small FMS** knob to enter the first letter of the destination waypoint identifier. Turn the **large FMS** knob to the right to move the cursor to the next character position.
3. Repeat step 2 to spell out the rest of the waypoint identifier.
4. Press the **ENT** key to confirm the identifier. The 'Activate?' field is highlighted.
5. Press the **ENT** key to activate.

To select a Direct-to destination to a flight plan waypoint or nearest airport:

1. Press the **Direct-to** (D➤) key.
2. Turn the **large FMS** knob to highlight the Flight Plan Field or Nearest Airport Field.
3. Turn the **small FMS** knob to display a list of waypoints or airports.

- Continue turning the **small FMS** knob to scroll through the list and highlight the desired waypoint or airport.
- Press the **ENT** key to confirm the selection. Press **ENT** again to activate a Direct-to.

To re-center the CDI (HSI) needle to the same destination waypoint:

- Press the **Direct-to** (**D▶**) key, followed by pressing the **ENT** key twice. NOTE: If a missed approach point (MAP) is the current destination, the approach will be canceled.

To manually define the Direct-to course:

- Press the **Direct-to** (**D▶**) key.
- Turn the **FMS** knobs to select the destination waypoint.
- Press the **ENT** key to confirm the selected waypoint, then turn the **large FMS** knob to highlight the Direct-to Course field.
- Turn the **FMS** knobs to select the desired course and press the **ENT** key.
- Press the **ENT** key again to begin navigation using the selected destination and course.

Canceling Direct-to Navigation:

- Press the **Direct-to** (**D▶**) key.
- Press the **MENU** key to display the Direct-to options menu.
- With 'Cancel Direct-To NAV' highlighted, press the **ENT** key. If a flight plan is still active, the G1000 resumes navigating the flight plan along the closest leg.

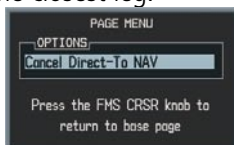

Figure 7-3 Canceling Direct-to Navigation

Direct-to Navigation from the PFD

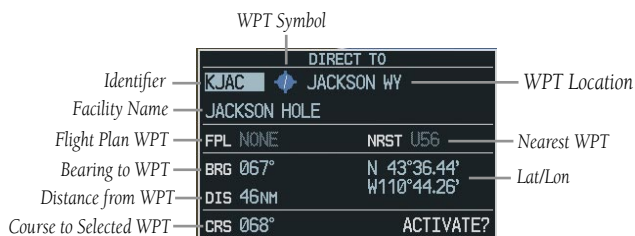

Figure 7-4 PFD Direct-to Window

- Press the Direct-to key (**D▶**).
- Turn the **large FMS** knob to place the cursor in the desired selection field.
- Turn the **small FMS** knob to begin selecting the desired identifier, location, etc.
- Press the **ENT** key.
- The cursor is now flashing on 'ACTIVATE?'. Press the **ENT** key again to activate.

Canceling Direct-to Navigation:

- Press the Direct-to (**D▶**) key.
- Press the **MENU** key to display the Options Window. The cursor will be flashing on 'Cancel Direct-to NAV'.
- Press the **ENT** key to cancel the direct-to.

7.3 AIRPORT INFORMATION

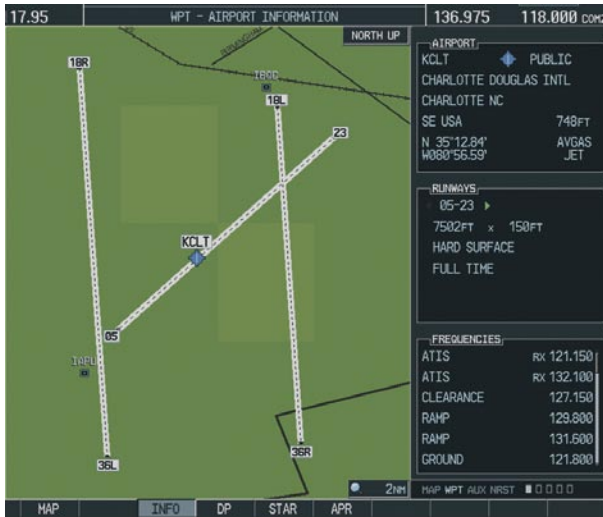

Figure 7-5 Airport Information Page

Select the Airport Information Page

1. Turn the **large FMS** knob to select the 'WPT' page group. Turn the **small FMS** knob to select the first rectangular page icon.

Enter a Waypoint Facility Name or City Location:

1. Press the **FMS** knob to activate the cursor.
2. Turn the **large FMS** knob to select the facility name or location (city) field.
3. Turn the **small FMS** knob to select the desired character.
4. Turn the **large FMS** knob to select the next character field.
5. Repeat steps 3 and 4 until the facility name or location is selected, then press the **ENT** key. If there are duplicate names in the database, a list is displayed from which to choose the desired location.

7. To remove the flashing cursor, press the **FMS** knob.

Access Runway Information

1. Press the **FMS** knob to activate the cursor.
2. Turn the **large FMS** knob to place the cursor on the Runways field.
3. Turn the **small FMS** knob to display the next runway for the selected airport.
4. Continue turning the **small FMS** knob to select the desired runway.
5. To remove the flashing cursor, press the **FMS** knob.

Access Frequency Information

1. Press the **FMS** knob to activate the cursor.
2. Turn the **large FMS** knob to move the cursor to the Frequencies window.
3. Turn either **FMS** knob to scroll through the list, placing the cursor on the desired frequency.
4. Press the **ENT** key to place the selected frequency in the standby field of the 'COM' or 'NAV' window.
5. To remove the flashing cursor, press the **FMS** knob.
 - 'TX' – transmit only
 - 'RX' – receive only
 - 'PT' – part time frequency
 - 'i' – additional information exists, press the **ENT** key

If a listed frequency has sector or altitude restrictions, the frequency is preceded by an info designation.

7.4 INTERSECTION INFORMATION

Select the Intersection Information Page

1. Turn the **large FMS** knob to select the WPT page group.
2. Turn the **small FMS** knob to select the second rectangular page icon.

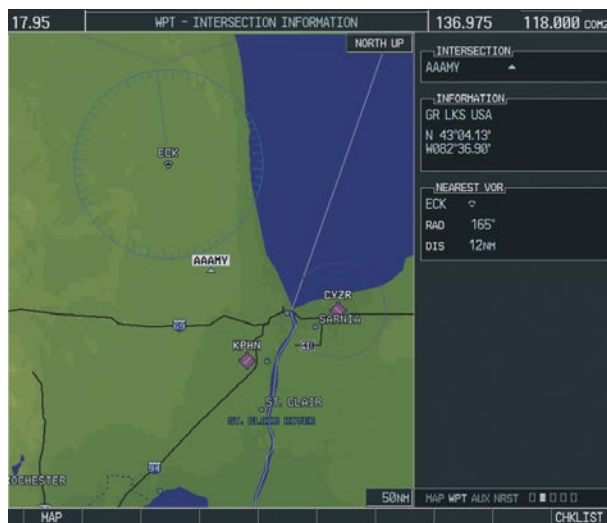

Figure 7-6 Intersection Information Page

Access Information on an Intersection

1. With the Intersection Information Page displayed, press the **FMS** knob to activate the cursor.
2. Turn the **FMS** knobs to enter a name for the identifier and press the **ENT** key.
3. Press the **FMS** knob to remove the flashing cursor.

7.5 NDB INFORMATION



Figure 7-7 NDB Information Page

Select the NDB Information Page

1. Turn the **large FMS** knob to select the WPT page group.
2. Turn the **small FMS** knob to select the third rectangular page icon

View Information on a Specific NDB:

1. With the NDB Information Page displayed, press the **FMS** knob to activate the cursor.
2. Turn the **large FMS** knob to highlight the desired selection field (identifier, name or closest city).
3. Turn the **FMS** knobs to enter an identifier, name or city and press the **ENT** key.
4. Press the **FMS** knob to remove the flashing cursor.



NOTE: The ADF cannot be auto-tuned from this page.

7.6 VOR INFORMATION



Figure 7-8 VOR Information Page

Select the VOR Information Page

1. Turn the **large FMS** knob to select the WPT page group.
2. Turn the **small FMS** knob to select the fourth rectangular page icon.

Access Information on a VOR:

1. With the VOR Information Page displayed, press the **FMS** knob to activate the cursor.
2. Turn the **large FMS** knob to highlight the desired selection field (identifier, name or closest city).
3. Turn the **FMS** knobs to enter an identifier, name or city and press the **ENT** key.
4. Press the **FMS** knob to remove the flashing cursor.

7.7 USER WAYPOINT INFORMATION PAGE

See the Flight Planning section for a discussion on creating and modifying user defined waypoints.

7.8 NEAREST AIRPORTS



Figure 7-9 Nearest Airports Page

Nearest Airport Information on the MFD

Select the Nearest Airports Page

1. Turn the **large FMS** knob to select the NRST page group.
2. Turn the **small FMS** knob to select the first rectangular page icon.

Access Information on a Specific Airport

1. Press the **APT** softkey located at the bottom of the display. The first airport in the nearest airports list is highlighted.
2. Turn the **large FMS** knob to highlight the desired airport.

Access Runway Information for the Selected Airport

1. Press the **RNWX** softkey located at the bottom of the display.
2. Turn the **small FMS** knob to select the desired runway.

Quickly Tune the COM Transceiver to a Nearby Airport Frequency

1. Press the **FREQ** softkey located at the bottom of the display.
2. Turn either **FMS** knob to select the desired frequency.
3. Press the **ENT** key. The selected frequency is placed in the standby frequency tuning box.
4. Press the **Frequency Toggle** key to place the frequency in the active field.

Nearest Airports Information on the PFD

Airport Symbol	Identifier	Bearing TO	Distance	Runway Length	Primary COM Frequency
	NEAREST AIRPORTS				
	U56	325°	9.3NM	VFR	
	MULTICOM	122.900	RNWX	3500FT	
	KIDA	261°	9.5NM	ILS	
	TOWER	118.500	RNWX	9001FT	
	KRXE	352°	20.1NM	VOR	
	UNICOM	122.800	RNWX	4200FT	

Figure 7-10 Nearest Airports Window

1. Press the **NRST** softkey to display the PFD Nearest Airports Window.

View Information on a Specific Airport in the List

1. Turn the **large FMS** knob to place the cursor on the desired airport identifier.

2. Press the **ENT** key to display airport information.
3. Press the **ENT** key again (cursor is on 'BACK') to return to the list.

Load an Airport COM Frequency into the Active COM

1. Turn the **large FMS** knob to place the cursor on the desired airport frequency shown in the window.
2. Press the **ENT** key and the selected frequency will become the standby frequency for the active COM.
3. Press the **Frequency Toggle** key to make the frequency the active frequency.

7.9 NEAREST INTERSECTIONS



Figure 7-11 Nearest Intersections Page

Select the Nearest Intersections Page

1. Turn the **large FMS** knob to select the NRST page group.

- Turn the **small FMS** knob to select the second rectangular page icon.

View Information on the Nearest Intersection

- Press the **FMS** knob to activate the cursor.
- Turn either **FMS** knob to select the desired intersection. Press the **ENT** key.

7.10 NEAREST NDB

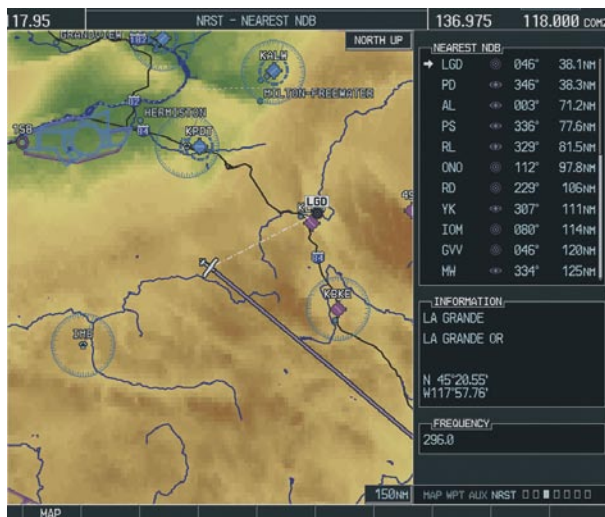

Figure 7-12 Nearest NDB Page

Select the Nearest NDB Page

- Turn the **large FMS** knob to select the NRST page group.
- Turn the **small FMS** knob to select the third rectangular page icon.

Access Information on a Specific NDB

- Press the **FMS** knob to activate the cursor.
- Turn either **FMS** knob to select the desired NDB. Press the **ENT** key. The remaining information on the Nearest NDB Page pertains to the selected NDB.



NOTE: The ADF cannot be auto-tuned from this page.

7.11 NEAREST VOR

Select the Nearest VOR Page

- Turn the **large FMS** knob to select the NRST page group.
- Turn the **small FMS** knob to select the fourth rectangular page icon.



Figure 7-13 Nearest VOR Page

View Information on the Nearest VOR:

- With the Nearest VOR Page selected, press the **VOR** softkey.
 - Turn either **FMS** knob to select a VOR. Press the **ENT** key.
- OR
- Press the **MENU** key. Select the Select VOR Window option and press the **ENT** key. Turn either **FMS** knob to select a VOR.

Select and Load a VOR Frequency

1. With the Nearest VOR Page selected, press the **FREQ** softkey to highlight the VOR frequency for the selected VOR.
 2. Press the **ENT** key. The selected VOR frequency is placed in the NAV standby frequency field.
- OR
1. Press the **MENU** key. Select the Select Frequency Window option and press the **ENT** key. Press the **ENT** key again when the frequency field is highlighted to place the selected VOR frequency in the NAV standby field.

7.12 NEAREST USER WAYPOINT



Figure 7-14 Nearest User Waypoints Page

Select the Nearest User Waypoint Page

1. Turn the **large FMS** knob to select the NRST page group.
2. Turn the **small FMS** knob to select the fifth rectangular page icon.

Select a Nearest User Waypoint

1. With the Nearest User Waypoint Page selected, press the **FMS** knob to activate the cursor.
2. Press the **ENT** key to select the Nearest User Waypoint.
3. The remaining information on the Nearest User Waypoint Page pertains to the selected Nearest User Waypoint.

7.13 NEAREST FREQUENCIES

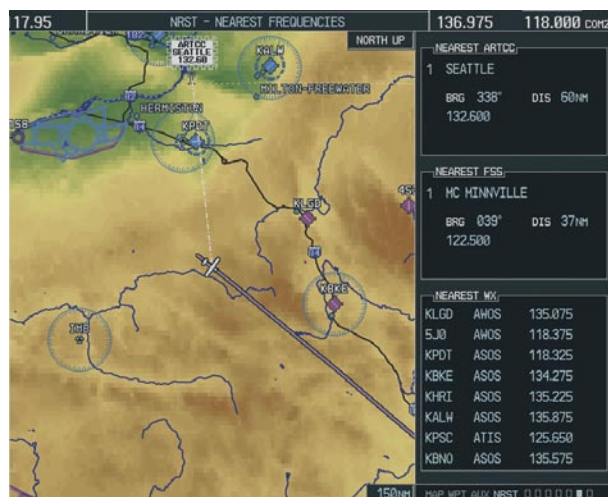

Figure 7-15 Nearest Frequencies Page

Select the Nearest Frequencies Page

1. Turn the **large FMS** knob to select the NRST page group.
2. Turn the **small FMS** knob to select the sixth rectangular page icon.

Select and Load the Nearest ARTCC, FSS, or Weather Frequency

1. With the Nearest Frequencies Page selected, press the **ARTCC, FSS,** or **Wx** softkey.
2. Turn the **large FMS** knob to select the frequency.
3. Press the **ENT** key to load the frequency into the 'COM' frequency standby field.

7.14 NEAREST AIRSPACES

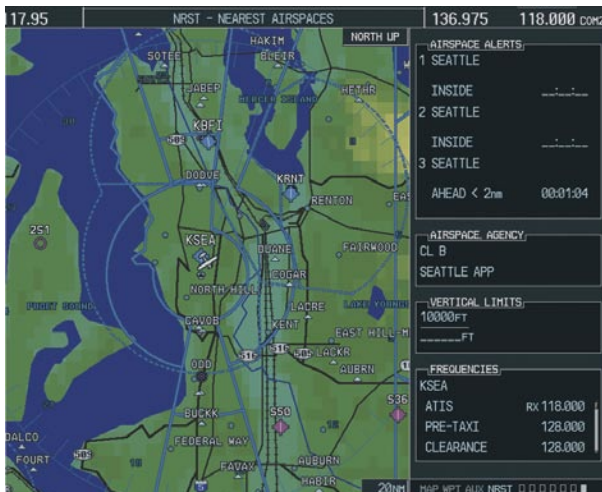

Figure 7-16 Nearest Airspaces Page

Select the Nearest Airspaces Page

1. Turn the **large FMS** knob to select the NRST page group.
2. Turn the **small FMS** knob to select the seventh rectangular page icon.

Airspace Alerts Box

- If the projected course takes the aircraft into an airspace within the next ten minutes, 'Ahead' is displayed.

- If the aircraft is within two nautical miles of an airspace and the current course takes the aircraft inside, 'Ahead < 2 nm' is displayed.
- If the aircraft is within two nautical miles of an airspace and the current course will not take the aircraft inside, 'Within 2 nm' is displayed.
- If the aircraft has entered an airspace, 'Inside' is displayed.

View Additional Details for a Listed Airspace

1. Select the Nearest Airspace Page.
2. Press the **FMS** knob to activate the cursor.
3. Turn the **large FMS** knob to scroll through the list, highlighting the desired airspace.
4. Press the **ALERTS** softkey and turn either **FMS** knob to select the desired airspace.
5. Press the **FMS** knob to remove the flashing cursor.

View and Quickly Load the Frequency for a Controlling Agency

1. Select the Nearest Airspaces Page.
2. Press the **FREQ** softkey and turn either **FMS** knob to select the desired frequency. Press the **ENT** key to load the frequency into the 'COM' frequency standby field.

This page intentionally left blank.

SECTION 8: FLIGHT PLANNING

The following discussions pertain to the Multi-function Display, unless otherwise indicated.

8.1 USER DEFINED WAYPOINTS

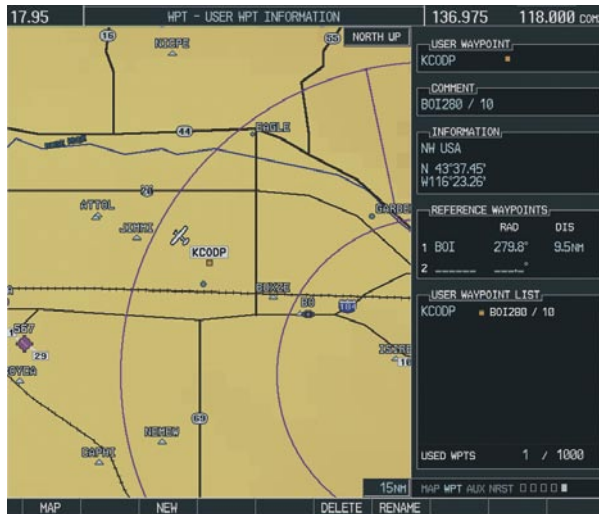

Figure 8-1 User WPT Information Page

Select the User WPT Information Page

1. Turn the **large FMS** knob to select the NRST page group.
2. Turn the **small FMS** knob to select the fifth rectangular page icon.

Create a New User Waypoint

1. With the User Waypoint Information Page displayed, press the **FMS** knob to activate the cursor.
2. Turn the **FMS** knobs to enter a name for the new waypoint and press the **ENT** key. The message 'Are you sure you want to create the new user waypoint' is displayed. With 'YES' highlighted, press the **ENT** key.

3. Turn the **large FMS** knob to highlight the latitude/longitude field or the Reference Waypoints field, depending on how the waypoint is to be defined.
4. Turn the **FMS** knobs to enter the position coordinates or the radial and distance from the reference waypoint.
5. Press the **ENT** key to accept the new waypoint.
6. Press the **FMS** knob to remove the flashing cursor.

Create User Waypoints from the Navigation Map Page

1. With the Navigation Map Page displayed, push the **joystick** to activate the panning function. The target pointer is displayed at the present aircraft position.
2. After placing the pointer at the desired position, press the **ENT** key. The User Waypoint Information Page is now displayed with the captured position.
3. Turn the **FMS** knobs to select a waypoint name.
4. Press the **ENT** key to accept the selected name. The first reference waypoint field is highlighted.
5. If desired, turn the **FMS** knobs to enter the identifier of the reference waypoint and the radial and distance to the reference waypoint. Press the **ENT** key to accept.
6. Press the **FMS** knob to remove the flashing cursor.

Modify a User Waypoint

1. With the User Waypoint Information Page displayed, press the **FMS** knob to activate the cursor.
2. Turn the **large FMS** knob to move the cursor to the desired field and turn the **small FMS** knob to make changes.
3. Press the **ENT** key to accept the changes.
4. Press the **FMS** knob to remove the flashing cursor.

Delete a User Waypoint

1. Select the User Waypoint Information Page and press **MENU** to display the User Waypoint Information Page Options or press the **DELETE** softkey.
2. Turn the **large FMS** knob to select 'Delete User Waypoint' and press the **ENT** key. The message 'Would you like to delete the user waypoint' is displayed. With 'YES' highlighted, press the **ENT** key.

8.2 VIEWING THE ACTIVE FLIGHT PLAN

1. Press the **FPL** key.



Figure 8-2 Active Flight Plan Page on the MFD



Figure 8-3 Active Flight Plan Window on the PFD

8.3 ACTIVATE A STORED FLIGHT PLAN

1. Press the **FPL** key and turn the **small FMS** knob to display the Flight Plan Catalog Page.

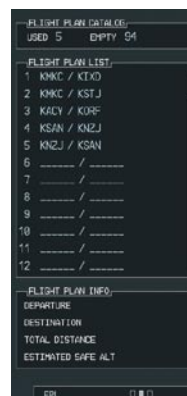

Figure 8-4 Flight Plan Catalog Page

2. Press the **FMS** knob to activate the cursor.
3. Turn the **large FMS** knob to highlight the desired flight plan and press the **ACTIVE** softkey.
4. With OK highlighted, press the **ENT** key to activate the flight plan. To cancel the flight plan activation, turn the **large FMS** knob to highlight 'CANCEL' and press the **ENT** key.

8.4 ACTIVATE A FLIGHT PLAN LEG

1. From the Active Flight Plan Page, press the **FMS** knob to activate the cursor and turn the **large FMS** knob to highlight the desired destination waypoint.

2. Press the **ACT LEG** softkey (using MFD only).
OR
3. Press the **MENU** key, select the 'Activate Leg' option from the page menu and press the **ENT** key. This step must be used when activating a leg from the PFD.
4. With 'Activate' highlighted, press the **ENT** key.

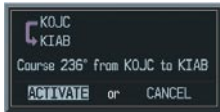

Figure 8-5 Activate Flight Plan Leg Confirmation

8.5 STOP NAVIGATING A FLIGHT PLAN

1. Press the **FPL** key to display the Active Flight Plan Page.
2. Press the **MENU** key to display the Page Menu window.

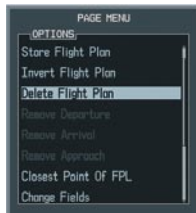

Figure 8-6 Delete Flight Plan

3. Turn the **large FMS** knob to highlight 'Delete Flight Plan' and press the **ENT** key. With 'OK' highlighted, press the **ENT** key to deactivate the flight plan. This will not delete the stored flight plan, only the active flight plan.

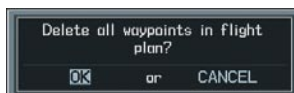

Figure 8-7 Delete Flight Plan Confirmation

8.6 INVERT ACTIVE FLIGHT PLAN

1. From the Active Flight Plan Page, press the **MENU** key to display the Page Menu.
2. Turn the **large FMS** knob to highlight 'Invert Flight Plan' and press the **ENT** key. The original flight plan remains intact in its flight plan catalog storage location.
3. With 'OK' highlighted, press the **ENT** key to invert the flight plan.

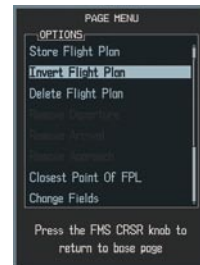

Figure 8-8 Invert Flight Plan

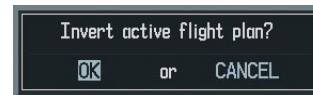

Figure 8-9 Invert Flight Plan Confirmation

8.7 CREATE A NEW FLIGHT PLAN

To create a new flight plan using the MFD:

1. Press the **FPL** key and turn the **small FMS** knob to display the Flight Plan Catalog Page.
2. Press the **NEW** softkey to display a blank flight plan page for the first empty storage location.

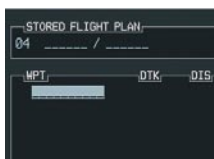

Figure 8-10 Create FPL on MFD

- Turn the **small FMS** knob to display the Waypoint Information Page. Turn the **small FMS** knob to enter the first character of the identifier of the departure waypoint. Turn the **large FMS** knob to move the cursor to the next character field. Repeat using the **FMS** knobs until the desired identifier has been entered.



Figure 8-11 Waypoint Info Window

- Press the **ENT** key.
- Repeat step number 3 to enter the identifier for each additional flight plan waypoint.
- When all waypoints have been entered, press the **FMS** knob to return to the Flight Plan Catalog Page. The new flight plan is now in the list.

To create a new flight plan using the PFD



NOTE: A flight plan cannot be entered using the PFD if another flight plan is active.



NOTE: After the first leg is entered (using the PFD only), it is immediately activated.

- Press the **FPL** key and press the **small FMS** knob to activate the cursor.
- Turn the **small FMS** knob to enter the first character of the flight plan starting identifier.
- Turn the **large FMS** knob to move the cursor to the next character field.
- Turn the **small FMS** knob to enter the next character. Continue this process until the desired identifier is entered.
- Press the **ENT** key and the cursor is now ready for entering of the next flight plan waypoint.
- Repeat steps 2 through 5 to enter the identifier for each additional flight plan waypoint.
- Once all waypoints have been entered, press the **FMS** knob to return to the Active Flight Plan Window.

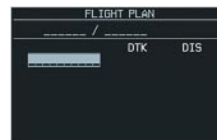

Figure 8-12 Creating Flight Plan on the PFD

8.8 LOAD A DEPARTURE

See the Procedures section for a discussion on loading and activating departure procedures.

8.9 LOAD AN ARRIVAL

See the Procedures section for a discussion on loading and activating arrival procedures.

8.10 LOAD AN APPROACH

See the Procedures section for a discussion on loading and activating approach procedures.

8.11 REMOVE A DEPARTURE, ARRIVAL, OR APPROACH FROM A FLIGHT PLAN

1. With the Active or Stored Flight Plan Page displayed, press the **small FMS** knob to activate the cursor.
2. Turn the **large FMS** knob to highlight the title for the approach, departure or arrival to be deleted. Titles appear in white directly above the procedure's waypoints.
3. Press the **CLR** key to display a confirmation window. With 'OK' highlighted, press the **ENT** key to remove the selected procedure.

8.12 STORE A FLIGHT PLAN

1. From the Flight Plan Page, press the **FMS** knob to activate the cursor.
2. Turn the **large FMS** knob to highlight the desired flight plan and press the **MENU** key to display the Flight Plan Page options.
3. Turn the **large FMS** knob to highlight 'Store Flight Plan' and press the **ENT** key.
4. With 'OK' highlighted, press the **ENT** key to store the flight plan.

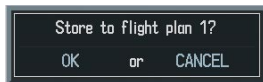

Figure 8-13 Store Flight Plan Confirmation

8.13 EDIT A STORED FLIGHT PLAN

1. Press the **FPL** key and turn the **small FMS** knob to display the Flight Plan Catalog Page.
2. Press the **FMS** knob to activate the cursor.
3. Turn the **large FMS** knob to highlight the desired flight plan and press the **ENT** key.

4. Turn the **FMS** knobs to make the desired changes, then press the **ENT** key.
5. Press the **FMS** knob to return to the Flight Plan Catalog Page.

8.14 DELETE A WAYPOINT FROM THE FLIGHT PLAN

1. Press the **FPL** key and turn the **small FMS** knob to display the Flight Plan Catalog Page.
2. Press the **FMS** knob to activate the cursor.
3. Turn the **large FMS** knob to highlight the desired flight plan and press the **ENT** key.
4. Turn the **large FMS** knob to select the waypoint to be deleted and press the **CLR** key to display a 'REMOVE WAYPOINT' confirmation window.
5. With 'OK' highlighted, press the **ENT** key to remove the waypoint. To cancel the delete request, turn the **large FMS** knob to highlight 'CANCEL' and press the **ENT** key.
6. Once all changes have been made, press the **FMS** knob to return to the Flight Plan Page.

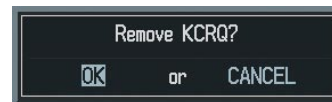

Figure 8-14 Remove Waypoint Confirmation

8.15 INVERT AND ACTIVATE A STORED FLIGHT PLAN

1. From the Flight Plan Catalog Page, press the **FMS** knob to activate the cursor.
2. Turn the **large FMS** knob to highlight the desired flight plan and press the **MENU** key to display the Page Menu options.

3. Turn the **large FMS** knob to highlight 'Invert Flight Plan' and press the **ENT** key. The original flight plan remains intact in its flight plan catalog storage location.
4. With 'OK' highlighted, press the **ENT** key to invert the flight plan.

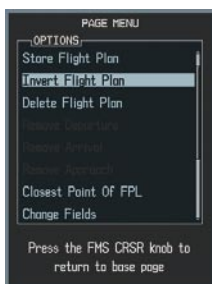

Figure 8-15 Invert Flight Plan

8.16 COPY A FLIGHT PLAN

1. From the Flight Plan Catalog press the **FMS** knob to activate the cursor, turn the **large FMS** knob to highlight the flight plan to be copied, then press the **MENU** key to display the Flight Plan Catalog Options.
2. Turn the **large FMS** knob to highlight 'Copy Flight Plan #' and press the **ENT** key.
3. A 'Copy to flight plan?' confirmation window is displayed. With 'OK' highlighted, press the **ENT** key to copy the flight plan. To cancel, turn the **large FMS** knob to highlight 'CANCEL' and press the **ENT** key.

8.17 DELETE A FLIGHT PLAN

1. From the Flight Plan Catalog Page, press the **FMS** knob to activate the cursor, turn the **large FMS** knob to highlight the flight plan to be deleted.

2. Press the **MENU** key to display the Flight Plan Catalog options.
3. Turn the **large FMS** knob to highlight 'Delete Flight Plan' and press the **ENT** key.
4. A 'Delete flight plan?' confirmation window is displayed. With 'OK' highlighted, press the **ENT** key to delete the flight plan. To cancel, turn the **large FMS** knob to highlight 'CANCEL' and press the **ENT** key.

8.18 GRAPHICAL FLIGHT PLAN CREATION

1. Press the **FPL** key to display the Active Flight Plan Page.
2. Press the **Joystick** to activate the map pointer. Use the **Joystick** to move the pointer to the desired point on the map to be inserted as a waypoint in the flight plan.
3. Press the **LD WPT** softkey. The selected waypoint will be inserted at the end of the flight plan.
4. If the selected waypoint is to be placed elsewhere in the flight plan, press the **FMS** knob to activate the cursor. Waypoints are inserted *ABOVE* the cursor.
5. After placing the cursor at the desired point in the list of waypoints, press the **LD WPT** softkey.

8.19 TRIP PLANNING

1. Turn the **large FMS** knob to select the AUX page group.
2. Turn the **small FMS** knob to select the first rectangular page icon.

- The current page mode is displayed at the top of the page: 'AUTOMATIC' or 'MANUAL'. To change the page mode, press the **AUTO** or **MANUAL** softkey.



Figure 8-16 Trip Planning Page

- For Direct-to planning, press the **WPTS** softkey and verify that the 'from' waypoint field indicates P.POS (present position). If necessary, press the **MENU** key and select 'Set WPT to Present Position' to display P.POS. Press the **ENT** key and the flashing cursor moves to the 'to' waypoint field. Turn the **FMS** knobs to enter the identifier of the 'to' waypoint and press the **ENT** key to accept the waypoint. OR,
- For point-to-point planning, turn the **FMS** knobs to enter the identifier of the 'from' waypoint. Once the waypoints identifier is entered, press the **ENT** key to accept the waypoint. The flashing cursor moves to the 'to' waypoint. Again, turn the **FMS** knobs to enter the identifier of the 'to' waypoint and press the **ENT** key to accept the waypoint. OR,
- For flight plan leg planning, press the **FPL** softkey (at the bottom of the display) and turn the **small FMS** knob to select the desired flight plan (already stored in memory), by number. Turn the **large FMS** knob to highlight the 'LEG' field and turn the **small FMS** knob to select the desired leg of the flight plan, or select 'CUM' to apply trip planning calculations to the entire flight plan.
- Turn the **large FMS** knob to highlight the departure time (DEP TIME) field.
- Turn the **FMS** knobs to enter the departure time. Press the **ENT** key when finished. (Departure time may be entered in local or UTC time, depending upon unit settings).
- Turn the **FMS** knobs to enter the fuel flow. Press the **ENT** key when finished. Note that in automatic page mode, fuel flow is provided by the system.
- The flashing cursor moves to the fuel on board field. Turn the **FMS** knobs to modify the fuel on board. Press the **ENT** key when finished. Note that in automatic mode this is provided by the system.
- The flashing cursor moves to the calibrated airspeed field. Turn the **FMS** knobs to enter a calibrated airspeed. Press the **ENT** key when finished.

8.20 VERTICAL NAVIGATION (VNAV) PAGE



NOTE: An active flight plan or Direct-to must be entered in order to utilize VNAV.



NOTE: VNAV is advisory only and cannot be coupled to the autopilot.

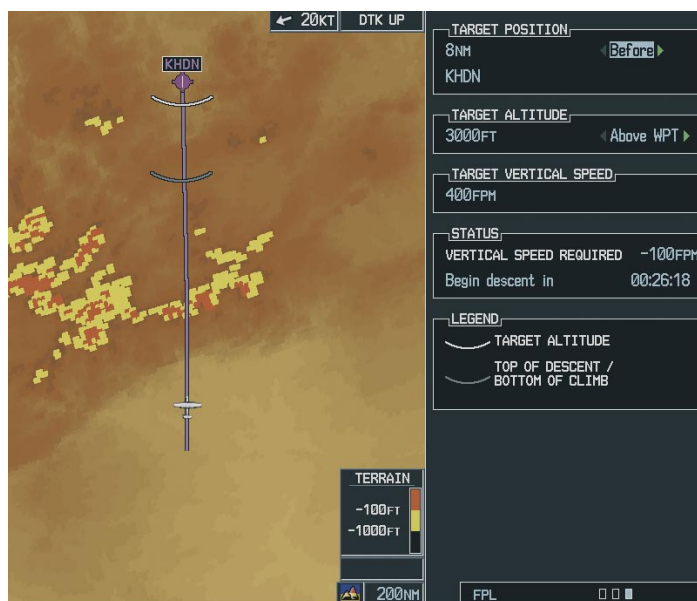

Figure 8-17 Vertical Navigation (VNAV) Page

To create a vertical navigation profile:

1. Select the Vertical Navigation Page.
2. Press the **FMS** knob to activate the cursor.
3. With the 'TARGET ALTITUDE' field highlighted, turn the **small and large FMS** knobs to select the target altitude and press the **ENT** key.
4. Turn the **small FMS** knob to select 'Above Wpt' (AGL) or 'MSL', and press the **ENT** key. 'Above Wpt' uses the altitude of a destination airport. 'MSL' lets you set a specific target altitude for any waypoint category: airport, VOR, NDB, intersection or user waypoint.
5. Turn the **small and large FMS** knobs to select a distance from the target reference waypoint and press the **ENT** key. If the target altitude should occur at the target reference waypoint, enter a distance of zero.
6. Turn the **small FMS** knob to select 'Before' or 'After', and press the **ENT** key. This setting designates whether the offset distance defines a point before you reach the target reference waypoint or after you reach the waypoint.
7. When using a flight plan, the target reference waypoint itself can be specified from the waypoints contained in the flight plan. By default, the last waypoint in the flight plan is selected. To select a different waypoint, turn the **small FMS** knob to select the desired waypoint and press the **ENT** key.
8. The default profile utilizes a 400 foot-per-minute descent rate. To change the rate, turn the **large FMS** knob to highlight the 'Target Vertical Speed' field and use the **small and large FMS** knobs to enter a new rate. Press the **ENT** key when finished.

With the profile set, the vertical speed required (VSR) is displayed. Expect the following to occur when using the vertical navigation feature:

At one minute prior to reaching the initial descent point, the message ‘APPR VPROF - Approaching VNAV Profile’ is displayed as a PFD alert. The descent (or climb) angle also locks to prevent changes in speed from altering the profile. If selected, the vertical speed required (VSR) readout on the default NAV and map pages shows the desired vertical speed to maintain the proper descent (or climb) angle. At 500 feet above (or below, for a climb) the target altitude, an ‘APPR TRG ALT’ - Approaching Target Altitude” message is provided. The VSR readout on the Navigation Map Page is blanked out at this point.

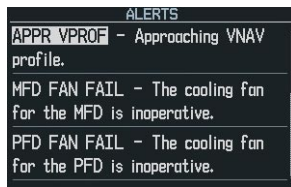

Figure 8-18 Approaching VNAV Profile Message (PFD)

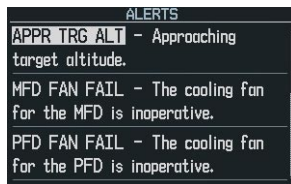

Figure 8-19 Approaching Target Altitude Message (PFD)

To display terrain or topo data on the Vertical Navigation Map Page, press the **MAP** softkey. Press the **TOPO**, **TERRAIN**, or **LTNG** softkey. Press the same softkey to remove the displayed data from the Vertical Navigation Page.

VNAV Page Menu Options

The VNAV messages are not enabled until the ‘VNAV Messages On?’ option is enabled from the VNAV Page Menu Options. To display the page menu, press the **MENU** key (with the VNAV Page displayed). The VNAV Page Options Menu also allows the pilot to restore VNAV page defaults.

This page intentionally left blank.

SECTION 9: PROCEDURES

9.1 ARRIVALS AND DEPARTURES

Load and Activate a Departure Procedure

1. With the Navigation Map Page displayed, press the **FPL** key.
2. Press the **LD DP** softkey. If a flight plan is active, the departure airport will be displayed as the default. A list of available departures is also displayed.
3. If no flight plan is active, use the **FMS** knobs to enter the identifier of the desired airport. Press the **ENT** key.
4. Turn the **large FMS** knob to highlight the Departure field. Turn the **small FMS** knob to display a list of available departures.
5. Turn either **FMS** knob to select the desired departure and press the **ENT** key.



Figure 9-1 Select Departure

6. A list of runways may be displayed for the departure. Turn either **FMS** knob to select the desired runway and press the **ENT** key.
7. A list of available transitions is displayed for the departure. Turn either **FMS** knob to highlight the desired transition waypoint and press the **ENT** key.



Figure 9-2 Select Departure Transition

8. With 'LOAD?' highlighted, press the **ENT** key. The departure will be active when the flight plan is active.

Load and Activate an Arrival Procedure

1. With the Navigation Map Page displayed, press the **FPL** key.
2. Press the **LD STAR** softkey. If a flight plan is active, the destination airport will be displayed as the default. A list of available arrivals is also displayed.
3. If no flight plan is active, use the **FMS** knobs to enter the identifier of the desired airport. Press the **ENT** key.
4. Turn the **large FMS** knob to highlight the Arrival field. Turn the **small FMS** knob to display a list of available arrivals.
5. Turn either **FMS** knob to select the desired arrival and press the **ENT** key.



Figure 9-3 Select Arrival

- A second window is displayed listing available transitions for the arrival. Turn either **FMS** knob to highlight the desired transition waypoint and press the **ENT** key.



Figure 9-4 Select Arrival Transition

- A third window is displayed listing the available runways. Turn either **FMS** knob to select the desired runway and press the **ENT** key.



Figure 9-5 Select Arrival Runway

- With 'LOAD?' highlighted, press the **ENT** key. If a flight plan is active, the selected arrival procedure is inserted after the destination airport and becomes part of the active flight plan. If no flight plan is active when the arrival is loaded, the arrival procedure will become the active flight plan.

9.2 APPROACHES

Load and/or Activate an Approach Procedure

- With the Navigation Map Page displayed, press the **FPL** key.
- Press the **LD APR** softkey. If a flight plan is active, the destination airport will be displayed as the default. A list of available approaches is also displayed.
- If no flight plan is active, use the **FMS** knobs to enter the identifier of the desired airport. Press the **ENT** key.
- Turn the **large FMS** knob to highlight the Approach field. Turn the **small FMS** knob to display a list of available approaches.



Figure 9-6 Selecting an Approach Procedure

- Turn either **FMS** knob to highlight the desired approach. Press the **ENT** key.
- The cursor will move to the TRANSITIONS field. Turn the **large FMS** knob to highlight the desired transition waypoint and press the **ENT** key. (The "Vectors" option assumes vectors will be received to the final course segment of the approach and will provide navigation guidance relative to the final approach course.)



Figure 9-7 Selecting an Approach Transition

7. Turn the **large FMS** knob to highlight 'Activate?' and press the **ENT** key to activate the approach. Selecting 'Load?' will add the procedure to the flight plan without immediately using it for navigation guidance.

Activate An Approach in the Active Flight Plan

1. With the Navigation Map Page displayed, press the **PROC** key.
2. Turn the **large FMS** knob to highlight 'ACTIVATE APPROACH'.
3. Press the **ENT** key. The approach procedure is now active.

This page intentionally left blank.

SECTION 10: HAZARD AVOIDANCE

10.1 CUSTOMIZING THE HAZARD DISPLAYS ON THE NAVIGATION MAP

1. With the Navigation Map Page displayed, press the **MENU** key to display the Navigation Map Page Menu. The cursor flashes on the 'Map Setup' option.
2. Press the **ENT** key. The Map Setup Menu is displayed. Turn the **small FMS** knob to select the 'Weather' or 'Traffic' group to customize the display of weather features. Select 'Traffic' to customize the display of traffic.
3. Press the **small FMS** knob to return to the Navigation Map Page.

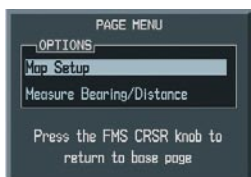

Figure 10-1 Page Menu



Figure 10-2 Map Setup Menu



Figure 10-3 Map Setup Group List

10.2 STORMSCOPE® (OPTIONAL)



WARNING: The Stormscope system is not intended to be used for hazardous thunderstorm penetration. Weather information on the G1000 MFD is approved for weather avoidance only. Refer to the WX-500 Pilot's Guide for detailed operation.

Displaying Stormscope Lightning Data on the Navigation Map Page

1. Press the **MAP** softkey.
2. Press the **STRMSCP** softkey. Press the **STRMSCP** softkey again to remove Stormscope Lightning Data from the Navigation Map Page.

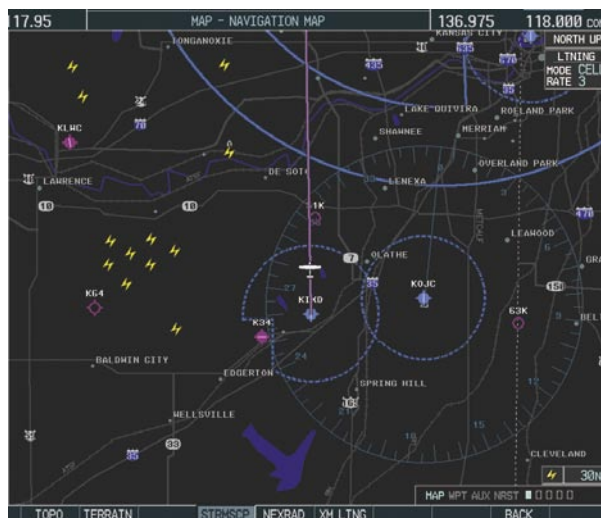

Figure 10-4 In-Flight Navigation Map Page Displaying Stormscope Lightning Data

Lightning Age	Symbol
Strike is less than 6 seconds old	
Strike is between 6 and 60 seconds old	
Strike is between 1 and 2 minutes old	
Strike is between 2 and 3 minutes old	

At a map range of less than 25 nm, Stormscope lightning data is not displayed, but can still be present. The presence of Stormscope lightning data is indicated by the annunciation 'LTNG < 25 nm' in the upper right corner.



Figure 10-5 Lightning Display Range Annunciation

To select 'cell' or 'strike' as the Stormscope lightning mode:

1. With the Weather Group selected, press the **ENT** key. The cursor flashes on 'STRMSCP LTNG'.
2. Turn the **large FMS** knob to select 'STRMSCP MODE'.
3. Turn either **FMS** knob to display the 'Cell/Strike' window.
4. Turn either **FMS** knob to select 'Cell' or 'Strike'. Press the **ENT** key.
5. Push the **FMS** knob to return to the Navigation Map Page.

To clear Stormscope lightning data from the Navigation Map Page:

1. Press the **MENU** key (with the Navigation Map Page displayed).
2. Turn either **FMS** knob to highlight the 'Clear Lightning Data' field and press the **ENT** key.



NOTE: If heading input is lost, strikes and/or cells must be cleared manually after the execution of each turn. This is to ensure that the strike and/or cell positions are depicted accurately in relation to the nose of the aircraft.

Stormscope Page

1. Turn the **large FMS** knob until the Map Page group is selected.
2. Turn the **small FMS** knob until the Stormscope Page is selected. This is the third rectangular page icon.



Figure 10-6 Stormscope Page

To change the Stormscope lightning mode between 'cell' and 'strike':

1. Select the Stormscope Page.
2. Press the **MODE** softkey. The **CELL** and **STRIKE** softkeys are displayed. Press the **CELL** softkey to display 'CELL' data or press the **STRIKE** softkey to display 'STRIKE' data. 'CELL' or 'STRIKE' is displayed in the mode box located in the upper left corner of the Stormscope Page.



NOTE: "Cell mode" uses a clustering program to identify clusters of electrical activity that indicate cells.

To change the viewing mode between 360° and 120°:

1. Select the Stormscope Page.
2. Press the **VIEW** softkey. The **360** and **ARC** softkeys are displayed. Press the **360** softkey to display a 360° viewing area or press the **ARC** softkey to display a 120° viewing area.

Press the **CLEAR** softkey to remove all Stormscope lightning data from the display.

10.3 XM WEATHER (SERVICE OPTIONAL)



WARNING: XM Weather is not intended to be used for hazardous weather penetration. Weather information provided by XM Radio Service is approved only for weather avoidance, not penetration.

1. Press the **MAP** softkey.
2. Press the **NEXRAD** or **XM LTNG** softkey to display the desired weather. Press the applicable softkey again to remove weather data from the Navigation Map Page.

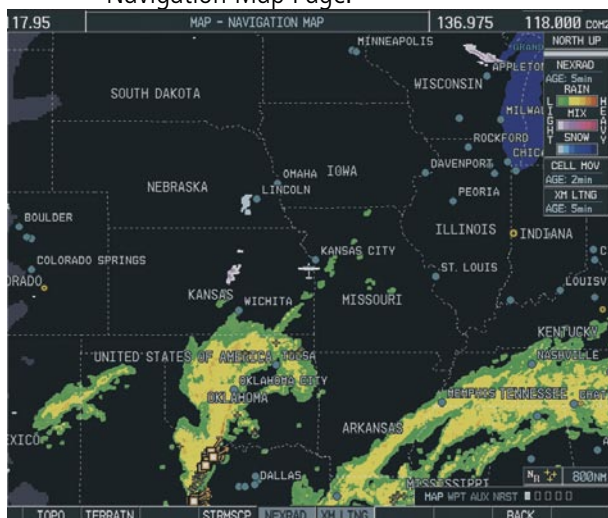

Figure 10-7 Navigation Map Page Displaying NEXRAD Weather



NOTE: Weather is not displayed on the Navigation Map Page at zoom levels less than 10 nm.

Displaying METAR and TAF information on the Airport Information Page

To display METAR and TAF text on the Airport Information Page:

1. Turn the **large FMS** knob to select the WPT Page Group.
2. Turn the **small FMS** knob to select the Airport Information Page.
3. Press the **WX** softkey to display METAR and TAF text (METAR and TAF information is updated every 12 minutes).

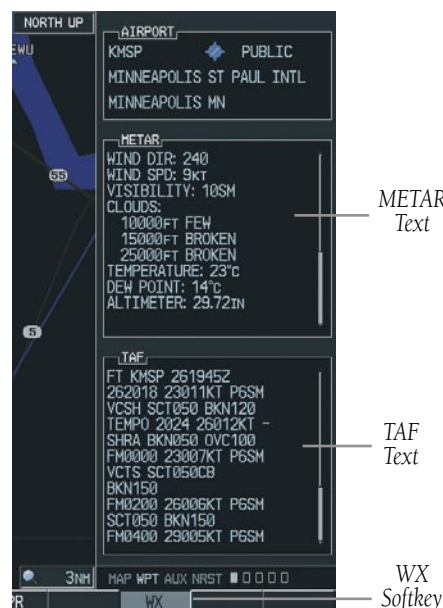

Figure 10-8 METAR and TAF Text Displayed on the Airport (Weather) Information Page

Displaying Weather on the Weather Data Link Page

To select the Weather Data Link Page:

1. Turn the **large FMS** knob to select the Map Page Group.
2. Turn the **small FMS** knob to select the fourth rectangular page icon.
3. Press the available softkeys to select the desired XM weather product.
4. Press the **LEGEND** softkey to view the legends for the selected products. If necessary, turn either **FMS** knob to scroll through the list. Press the **small FMS** knob or the **ENT** softkey to return to the map.

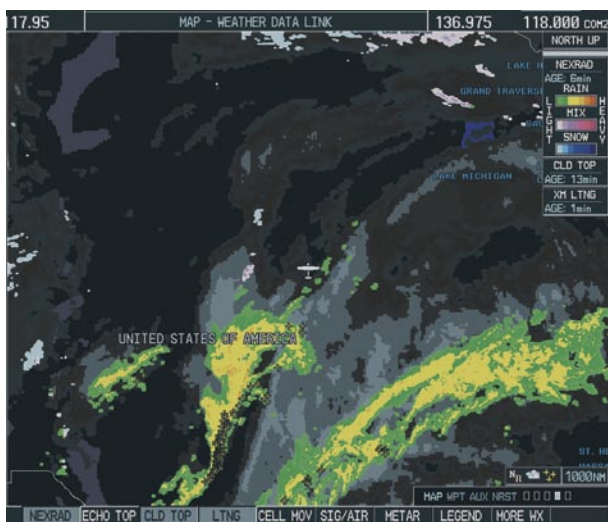

Figure 10-9 Weather Data Link Page

NEXRAD – Press the **NEXRAD** softkey to show NEXRAD weather and radar coverage information. Areas where radar coverage is not available will be shown in grayish-purple. The display is updated every five minutes.

NEXRAD Limitations

Certain limitations exist regarding the NEXRAD radar displays. Some, but not all, are listed here:

- NEXRAD base reflectivity does not provide sufficient information to determine cloud layers or precipitation characteristics (hail vs. rain, etc).
- An individual NEXRAD site cannot depict high altitude storms at close ranges, and has no information about storms directly over the site.
- The resolution of displayed NEXRAD data is 2 kilometers. Therefore, when zoomed in on the display, each square block is 2 kilometers. The intensity level reflected by the square will be the highest level sampled within the 2 kilometer square area.

ECHO TOP – Press the **ECHO TOP** softkey to show the location, elevation, and direction the highest radar echo. This may not indicate the top of a storm or clouds, only the highest radar return echo. ECHO TOPS cannot be displayed along with NEXRAD and CLOUD TOPS. When ECHO TOPS is activated, NEXRAD and CLOUD TOPS are removed. Refer to the Legend for a description of the ECHO TOPS coding. The display is updated every 7.5 minutes.

CLD TOP – Press the **CLD TOP** softkey to show the cloud top altitude determined from satellite imagery. The display is updated every 15 minutes.

LTNG – Pressing the **LTNG** softkey shows the location of cloud-to-ground lightning strikes. The display is updated every five minutes.



NOTE: Strikes depicted represent cloud to ground strikes within a 2 kilometer radius of the actual strike location. Therefore, the exact location of the strike is not displayed.

CELL MOV – Pressing the **CELL MOV** softkey shows storm cell movement by displaying an arrow pointing in the direction of predicted movement. The display is updated every 12 minutes.

SIG/AIR – Pressing the **SIG/AIR** softkey shows SIGMET and AIRMET information. The display is updated every 12 minutes.

METAR – Press the **METAR** softkey to graphically display METARs. METARs are shown as colored flags at airports providing METAR reports. The display is updated every 12 minutes.

MORE WX – Press the **MORE WX** softkey to display the following group of softkeys for additional weather control:

SFC – Pressing the **SFC** softkey for Surface Analysis shows current or forecast conditions. Forecasts are available for intervals of Current, 12, 24, 36, and 48 hours. Press the softkey corresponding to the desired forecast. The closest city forecast information is displayed in the legend. The display is updated every 12 minutes.

FRZ LVL – Press the **FRZ LVL** softkey to display contour lines for freezing levels. The display is updated every 12 minutes.

WIND – Press the **WIND** softkey to show wind speed and direction at a selected altitude from the ground up to 42,000 feet in 3,000 foot increments. After pressing the **WIND** softkey, press the softkey corresponding to the desired winds aloft altitude. The display is updated every 12 minutes.

COUNTY – Pressing the **COUNTY** softkey provides specific public awareness and protection weather warnings for Tornado, Severe Thunderstorm, and Flood conditions provided by the National Weather Service (NWS). The display is updated every 5 minutes.

CYCLONE – Pressing the **CYCLONE** softkey shows the current location of cyclones (hurricanes and tropical storms) and their projected track at various time intervals. The update rate is every 12 minutes.

Map Panning Information – Weather Data Link Page

1. Push in the **joystick** to display the panning arrow.
2. Move the **joystick** to place the panning arrow on AIRMETs, TFRs, METARs, or SIGMETs. Press the **ENT** key to display pertinent information for the selected product.

Note that pressing the **ENT** key when panning over an AIRMET or a SIGMET displays an information box that displays the text of the report. Panning over an airport with METAR information does not display more information but allows the user to press the **ENT** key and select that Airport's Information Page to display the text of the report. Pressing the **ENT** key when panning over a TFR displays TFR specific information.

Weather Products & Symbols

Figure 10-10 depicts the symbol for each weather product (read from left to right). When a weather product is active, the product symbol is displayed in the lower right of the screen.

- NEXRAD
- Cloud Top/Echo Top
- XM Lightning
- Cell Movement
- SIGMETs/AIRMETs
- METARs
- City Forecast

- Surface Analysis
- Freezing Levels
- Winds Aloft
- County Warnings
- Cyclone Warnings

 Echo Top (Cloud Top and Echo Top Mutually Exclusive)



Figure 10-10 Weather Product Symbols

The XM Information Page in the AUX Page Group will display the weather products available for the current subscription. A green box by the weather product means that it is available.

From within the AUX - XM INFORMATION page, the pilot may switch to the AUX - XM RADIO by pressing the RADIO softkey. Alternatively, the pilot may switch to the AUX - XM INFORMATION page from the AUX - XM RADIO page by pressing the INFO softkey.



NOTE: *The DONE softkey on the AUX - XM INFORMATION page is used to save the GDL 69(A) activation data when the XM services are initially set up. It is not used during normal operation of the GDL 69(A), but it should have no adverse effects if inadvertently selected during flight. Refer to the GDL 69/69A XM Satellite Radio Activation Instructions (190-00355-04, Rev E or later) for further information.*

Weather Product Age

The age for each of the enabled products is displayed on the right side of the display. Times are based on Zulu time when the data was assembled on the ground, not the time the data was received by the FIS sensor. When the age of a weather product has exceeded half of the expiration time, the product time will change from light blue to amber in color.

Weather Product	Expires After (minutes)
SIGMETs/AIRMETs	60
City Forecasts	60
County Warnings	60
Cyclone Warnings	60
Echo Tops	30
Freezing Levels	60
METARs	90
Lightning	30
NEXRAD	30
Radar Coverage	30
Cell Movement	30
Surface Analysis	60
TFRs	60
Winds Aloft	90
TAFs	60
Clouds Tops	60

10.4 TRAFFIC INFORMATION SERVICE (TIS)



NOTE: Traffic Information Service (TIS) is only available when the aircraft is within the service volume of a TIS capable terminal radar site.



NOTE: If the G1000 is configured to use a Traffic Advisory System (TAS), TIS will not be available for use.

Displaying Traffic on the Traffic Map Page

1. Turn the **large FMS** knob to select the Map Page Group.
2. Turn the **small FMS** knob to select the second rectangular page icon.
3. Press the **OPERATE** softkey to begin displaying traffic. 'TIS OPERATING' is displayed in the Traffic mode field.
4. Press the **STANDBY** softkey to place the system in the Standby mode. 'TIS STANDBY' will be displayed in the Traffic mode field.
5. Rotate the **Joystick** clockwise to display a larger area or rotate counter-clockwise to display a smaller area.

If data is not received for a period longer than 6 seconds, the age of the present data will be displayed in the lower left of the screen along with the annunciation that the system has entered Coast mode. The system will maintain the traffic display (up to 60 seconds) until the next data reception. If no data is received after 60 seconds, traffic will be removed from the display.

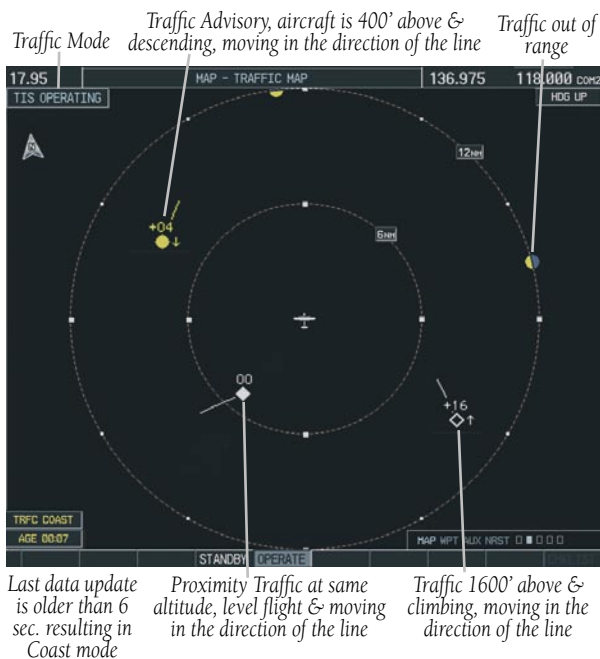

Figure 10-11 Traffic Map Page

Displaying Traffic on the Navigation Map

1. Ensure TIS is operating. With the Navigation Map displayed, press the **MAP** softkey.
2. Press the **TRAFFIC** softkey. Traffic will now be displayed on the map.

TIS Audio Alert

When a Traffic Advisory (TA) is displayed, an audio alert "Traffic" is given.

"Traffic Not Available" will be heard whenever TIS service becomes unavailable.

10.5 TRAFFIC ADVISORY SYSTEM (TAS) (OPTIONAL)

Refer to the Honeywell KTA 870 Pilot's Guide for a detailed discussion of the KTA 870 system.

System Self Test

1. Set the range to 2/6 nm.
2. Press the **STANDBY** softkey.
3. Press the **TEST** softkey.
4. Self test will take approximately eight seconds to complete. When completed successfully, traffic symbols will be displayed as shown in Figure 10-12 and a voice alert "TAS System Test OK" will be heard. If the self test fails, the system will revert to Standby mode and a voice alert "TAS System Test Fail" will be heard.



Figure 10-12 Self Test OK Display

Displaying Traffic on the Traffic Map Page

1. Turn the **large FMS** knob to select the Map Page Group.

2. Turn the **small FMS** knob to select the second rectangular page icon.
3. Press the **OPERATE** softkey to begin displaying traffic. 'TAS OPERATING' is displayed in the Traffic mode field.
4. Press the **ALT MODE** softkey to change the altitude volume. Select the desired altitude volume by pressing the the **BELOW**, **NORMAL**, **ABOVE**, or **UREST** (unrestricted) softkey. The selection is displayed in the Altitude mode field.
5. Press the **STANDBY** softkey to place the system in the Standby mode. 'TAS STANDBY' will be displayed in the Traffic mode field.
6. Rotate the **Joystick** clockwise to display a larger area or rotate counter-clockwise to display a smaller area.

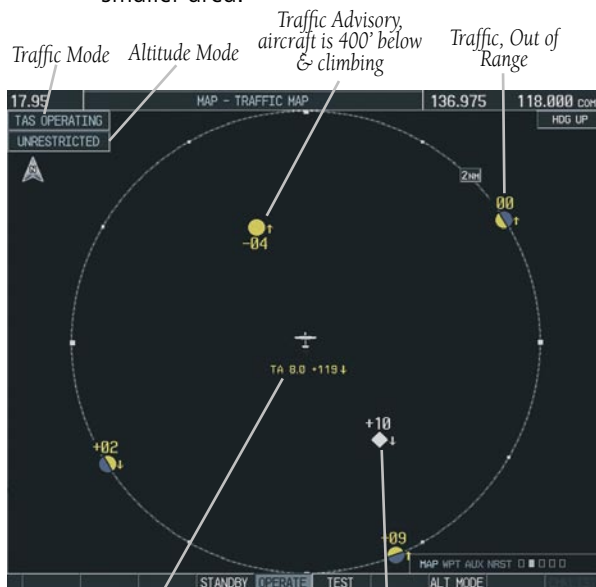

Figure 10-13 Traffic Map Page

Displaying Traffic on the Navigation Map

1. Ensure the KTA 870 system is operating. With the Navigation Map displayed, press the **MAP** softkey.
2. Press the **TRAFFIC** softkey. Traffic will now be displayed on the map.

Traffic Advisory



Non-Bearing Traffic Advisories
Traffic Off Scale Banner
Non-Threat Traffic

Figure 10-14 TAS Traffic on Navigation Map

2. Turn the **small FMS** knob to select the last rectangular page icon.
3. If desired, press the **VIEW** softkey to access the **ARC** and **360** softkeys. When the **ARC** softkey is pressed, a radar-like 120° view is displayed. Press the **360** softkey to return to the 360° default display.
4. Rotate the **JOYSTICK** clockwise to display a larger area or rotate counter-clockwise to display a smaller area.

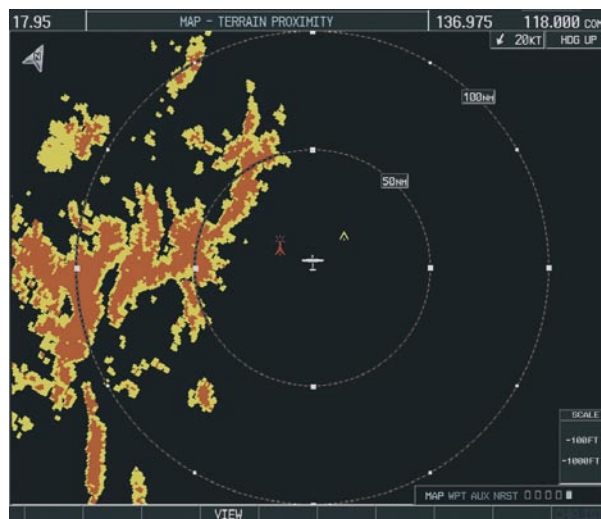

Figure 10-15 Terrain Proximity Page

10.6 TERRAIN AND OBSTACLE PROXIMITY



NOTE: Terrain data is not displayed when the aircraft latitude is greater than 75 degrees north or 60 degrees south.

Displaying Terrain and Obstacles on the Terrain Proximity Page

1. Turn the **large FMS** knob to select the Map Page Group.

Color	Indication
RED	WARNING: Terrain/Obstacle at or within 100' below current aircraft altitude.
YELLOW	CAUTION: Terrain/Obstacle between 100' and 1000' below current aircraft altitude.

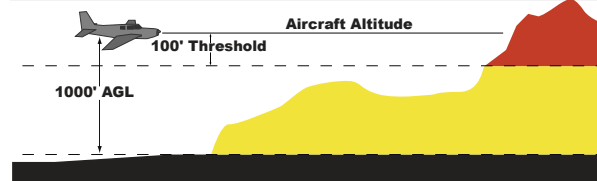

Unlighted Obstacle (Height is less than 1000' AGL)	Lighted Obstacle (Height is less than 1000' AGL)	Unlighted Obstacle (Height is greater than 1000' AGL)	Lighted Obstacle (Height is greater than 1000' AGL)

Figure 10-16 Obstacle Symbols

Displaying Terrain and Obstacles on the Navigation Map

1. With the Navigation Map displayed, press the **MAP** softkey.
2. Press the **TERRAIN** softkey. Terrain and obstacle proximity will now be displayed on the map.

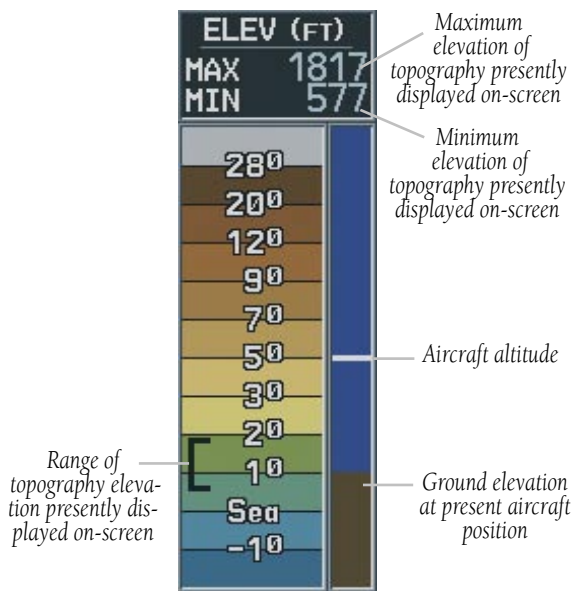

Figure 10-17 Topography Scale

10.7 TERRAIN AWARENESS & WARNING SYSTEM (TAWS) DISPLAY (OPTIONAL)



NOTE: Terrain data is not displayed when the aircraft latitude is greater than 75 degrees north or 60 degrees south.



NOTE: TAWS operation is only available when the G1000 is configured for a TAWS-B installation.

Displaying Terrain on the TAWS Page

1. Turn the **large FMS** knob to select the Map Page Group.
2. Turn the **small FMS** knob to select the TAWS Page.
3. If desired, press the **VIEW** softkey to access the **ARC** and **360** softkeys. When the **ARC** softkey is pressed, a radar-like 120° view is displayed. Press the **360** softkey to return to the 360° default display.
4. Rotate the **JOYSTICK** clockwise to display a larger area or rotate counter-clockwise to display a smaller area.

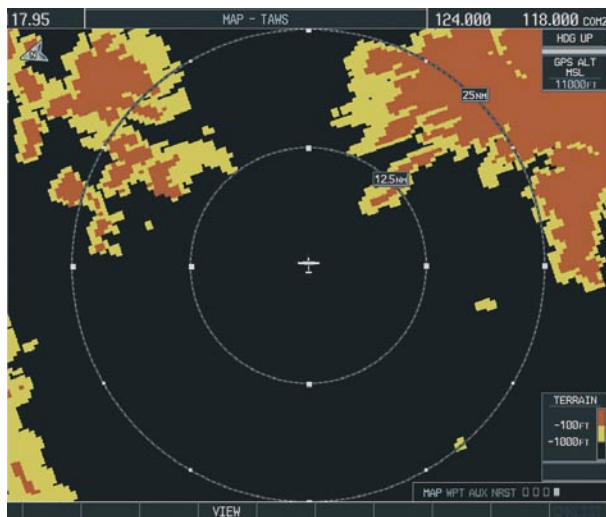

Figure 10-18 TAWS Page (360° View)

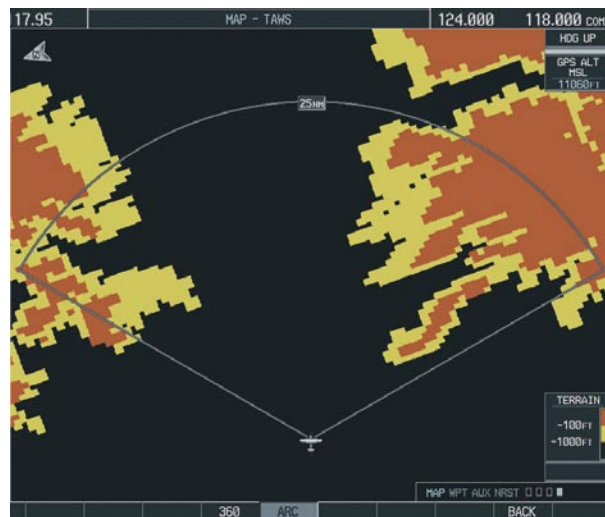
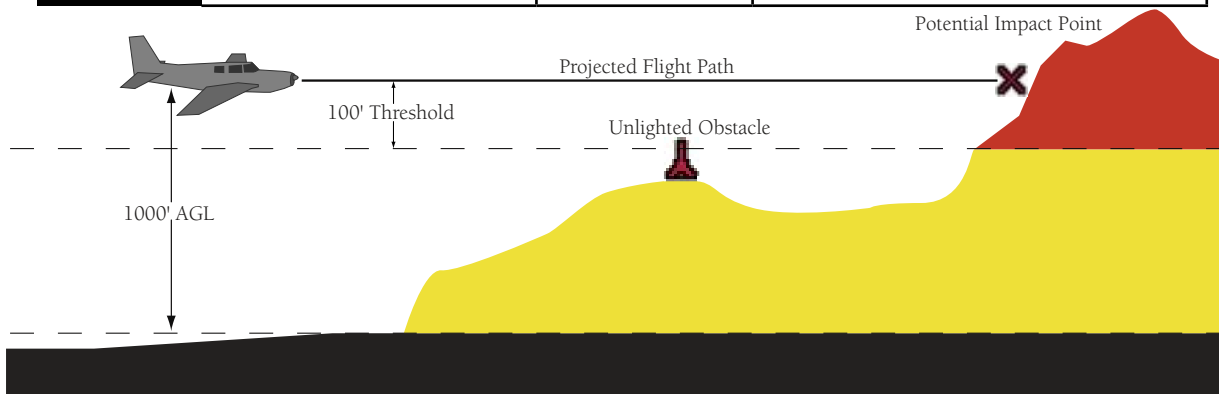

Figure 10-19 TAWS Page (ARC View)

Color	Terrain/Obstacle Location	Alert Level	Suggested Pilot Response
Red	Terrain/Obstacle at or within 100' below current aircraft altitude.	WARNING	Initiate climb and/or turn away from terrain/obstacle.
Yellow	Terrain/Obstacle between 100' and 1000' below current aircraft altitude.	CAUTION	Be aware of surroundings. Be prepared to take action.
Black	Terrain/Obstacle is more than 1000' below aircraft altitude.	NO DANGER	No action required.



Enable/Disable Aviation Data

1. While the TAWS Page is displayed, press the **MENU** key.
2. Turn the **small FMS** knob to select "Show (or Hide) Aviation Data".
3. Press the **ENT** key.



Figure 10-20 TAWS Page Menu

TAWS Inhibit

Flying VFR into an area where unique terrain exists could cause the system to annunciate a nuisance alert. When TAWS is inhibited, only FLTA and PDA alerts are disabled.

To Inhibit TAWS:

1. While the TAWS Page is displayed, press the **MENU** key.
2. Turn the **small FMS** knob to select 'Inhibit TAWS'.
3. Press the **ENT** key.

To Enable TAWS:

1. While the TAWS Page is displayed, press the **MENU** key.
2. Turn the **small FMS** knob to select 'Enable TAWS'.
3. Press the **ENT** key.

Manual System Test

A system test is automatically performed at power-up. After successful completion of the test, "**TAWS System Test, OK**" will be heard.

The system test may also be initiated manually, but only when the aircraft is on the ground. To manually verify proper operation of the aural and visual annunciations of the system, perform the following steps.

1. While the TAWS Page is displayed, press the **MENU** key.
2. Turn the **small FMS** knob to select 'Test TAWS'.
3. Press the **ENT** key. During the test 'TAWSTEST' is displayed in the center of the TAWS Page. When all is in working order, "TAWS System Test, OK" will be heard.

Forward Looking Terrain Avoidance (FLTA)

The Forward Looking Terrain Avoidance alert is composed of two sub-functions:

Reduced Required Terrain Clearance (RTC) and Reduced Required Obstacle Clearance (ROC)

This provides alerts when the aircraft flight path is above terrain and/or obstacles, yet is projected to come within minimum clearance values outlined in the following table. When an RTC or ROC alert is issued, a potential impact point is displayed on the TAWS Page as a yellow or red 'X'.

Imminent Terrain Impact (ITI) and Imminent Obstacle Impact (IOI)

This provides alerts when the aircraft is below the elevation of terrain in the aircraft's projected path. ITI and IOI alerts are accompanied by a potential impact point displayed on the TAWS Page as a yellow or red 'X'. The alert is given when the projected vertical flight path is calculated to come within minimum clearance altitudes in the following table.

Phase of Flight	Level Flight	Descending
Enroute	700 ft.	500 ft.
Terminal	350 ft.	300 ft.
Approach	150 ft.	100 ft.
Departure	100 ft.	100 ft.

During the final approach phase of flight, RTC/ROC/ITI/IOI alerts are automatically inhibited when the aircraft is below 200 feet AGL while within 0.5 nm of the approach runway or is below 125 feet AGL while within 1 nm of the runway.

Premature Descent Alert (PDA)

A Premature Descent Alert is issued when the system detects that the aircraft is significantly below the normal approach path to a runway. The PDA alert mode functions only during descent to land. There are three different scenarios to consider with PDA:

- No Approach Loaded - PDA alerting begins when the aircraft is within 15 nm of the destination airport and ends when the aircraft is either 0.5 nm from the runway threshold OR is at an altitude of 125 feet AGL while within 1 nm of the threshold. During the final descent, algorithms will set a threshold for alerting based on speed, distance, and other parameters.
- Non-Precision Approach Loaded - PDA alerting begins when the FAF is the active waypoint AND the aircraft is within 15 nm of the destination airport. Again, algorithms are used to set a threshold for alerting based upon various parameters. PDA alerting ends at 0.5 nm from the runway threshold OR at an altitude of 125 feet AGL while within 1 nm of the threshold.
- ILS Approach Loaded—PDA alerting begins when the FAF is the active waypoint AND the aircraft is within 15 nm of the destination airport. Prior to reaching the FAF, a PDA alert will be issued if the aircraft descends 200 feet below the FAF altitude. Once the aircraft intercepts the glideslope, PDA will

alert the pilot if the aircraft descends 0.7 degrees below the glideslope. PDA alerting ends 0.5 nm from the runway threshold OR at an altitude of 125 feet AGL while within 1 nm of the threshold.

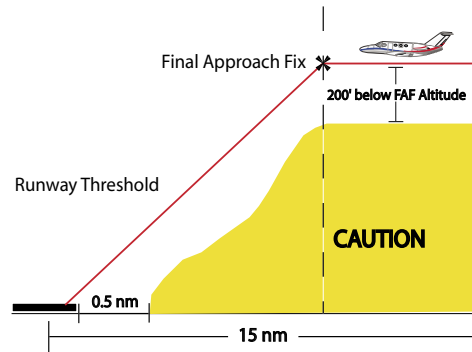

Figure 10-21 Non-Precision Approach PDA Alert Threshold

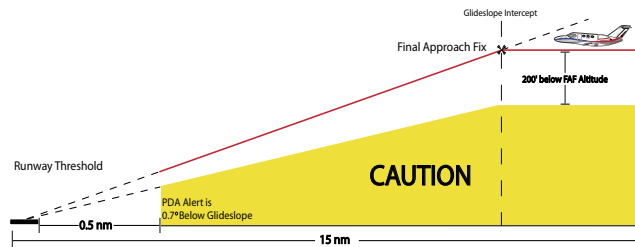

Figure 10-22 ILS Approach PDA Alert Threshold

Excessive Descent Rate Alert (EDR)

The purpose of the Excessive Descent Rate alert is to provide suitable alerts when the aircraft is determined to be closing (descending) upon terrain at an excessive speed. Figure 10-23 displays the correlation between height above terrain and descent rate, resulting in the two EDR alerts. EDR alerts have two levels of severity, caution (sink rate) and warning (pull-up).

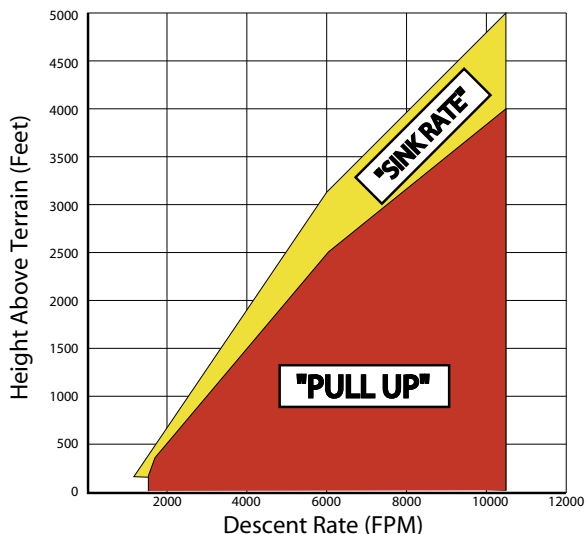

Figure 10-23 Excessive Descent Rate

Negative Climb Rate After Takeoff Alert (NCR)

The purpose of the Negative Climb Rate After Takeoff alert is to provide suitable alerts to the pilot when the system determines that the aircraft is losing altitude (closing upon terrain) after takeoff. The aural message “**Don’t Sink**” is given for NCR alerts, accompanied by an annunciation and a pop-up terrain alert on the display.

“Five-Hundred” Aural Alert

The purpose of the aural alert message “Five-hundred” is to provide an advisory alert to the aircrew that the aircraft is five-hundred feet above terrain. When the aircraft descends within 500 feet of terrain, the aural

message “**Five-hundred**” is heard. There are no display annunciations or pop-up alerts that accompany the aural message.

Displaying Terrain and Obstacles on the Navigation Map

1. With the Navigation Map displayed, press the **MAP** softkey.
2. Press the **TERRAIN** softkey. Terrain and obstacle proximity will now be displayed on the map.

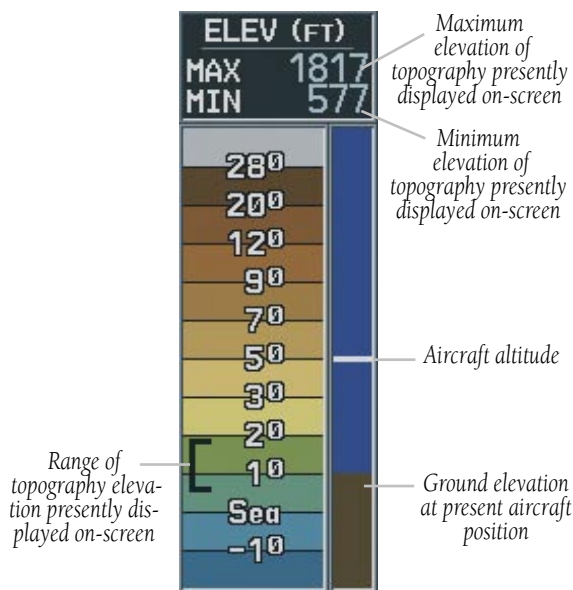

Figure 10-24 Topography Scale





Unlighted Obstacle (Height is less than 1000' AGL)	Lighted Obstacle (Height is less than 1000' AGL)	Unlighted Obstacle (Height is greater than 1000' AGL)	Lighted Obstacle (Height is greater than 1000' AGL)	Potential Impact Points
				

Figure 10-25 TAWS Symbols

Pop-up Alerts

When a terrain or obstacle alert is issued, a pop-up window is displayed on the MFD with the appropriate alert.

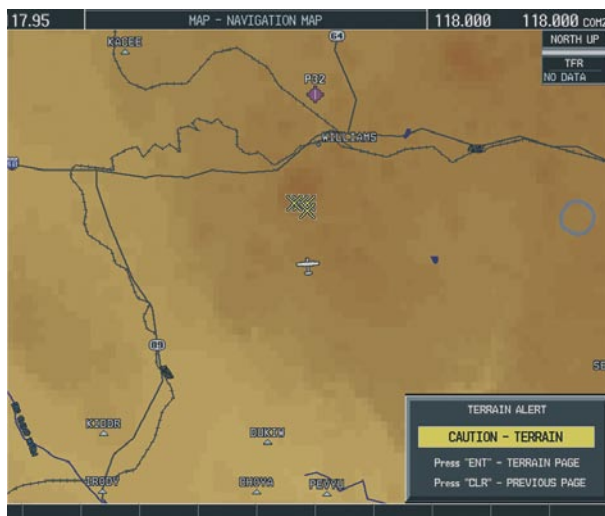

Figure 10-26 Alert Pop-Up

Press the **ENT** key to display the TAWS Page, or press the **CLR** key to remain on the existing page.

TAWS Alerts Summary

The following table shows the possible TAWS alert types with corresponding annunciations and aural messages.

Alert Type	PFD/MFD TAWS Page Annunciation	MFD Pop-Up Alert	Aural Message
Excessive Descent Rate Warning (EDR)	PULL UP	PULL-UP	"Pull Up"
Reduced Required Terrain Clearance Warning (RTC)	PULL UP	TERRAIN - PULL-UP or TERRAIN AHEAD - PULL-UP	"Terrain, Terrain; Pull Up, Pull Up" or "Terrain Ahead, Pull Up; Terrain Ahead, Pull Up"
Imminent Terrain Impact Warning (ITI)	PULL UP	TERRAIN AHEAD - PULL-UP or TERRAIN - PULL-UP	Terrain Ahead, Pull Up; Terrain Ahead, Pull Up" or "Terrain, Terrain; Pull Up, Pull Up"
Reduced Required Obstacle Clearance Warning (ROC)	PULL UP	OBSTACLE - PULL-UP or OBSTACLE AHEAD - PULL-UP	"Obstacle, Obstacle; Pull Up, Pull Up" or "Obstacle Ahead, Pull Up; Obstacle Ahead, Pull Up"
Imminent Obstacle Impact Warning (IOI)	PULL UP	OBSTACLE AHEAD - PULL-UP or OBSTACLE - PULL-UP	"Obstacle Ahead, Pull Up; Obstacle Ahead, Pull Up" or "Obstacle, Obstacle; Pull Up, Pull Up"
Reduced Required Terrain Clearance Caution (RTC)	TERRAIN	CAUTION - TERRAIN or TERRAIN AHEAD	"Caution, Terrain; Caution, Terrain" or "Terrain Ahead; Terrain Ahead"
Imminent Terrain Impact Caution (ITI)	TERRAIN	TERRAIN AHEAD or CAUTION - TERRAIN	"Terrain Ahead; Terrain Ahead" or "Caution, Terrain; Caution, Terrain"
Reduced Required Obstacle Clearance Caution (ROC)	TERRAIN	CAUTION - OBSTACLE or OBSTACLE AHEAD	"Caution, Obstacle; Caution, Obstacle" or "Obstacle Ahead; Obstacle Ahead"
Imminent Obstacle Impact Caution (IOI)	TERRAIN	OBSTACLE AHEAD or CAUTION - OBSTACLE	"Obstacle Ahead; Obstacle Ahead" or "Caution, Obstacle; Caution, Obstacle"
Premature Descent Alert Caution (PDA)	TERRAIN	TOO LOW - TERRAIN	"Too Low, Terrain"
Altitude Callout "500"	None	None	"Five-Hundred"
Excessive Descent Rate Caution (EDR)	TERRAIN	SINK RATE	"Sink Rate"
Negative Climb Rate Caution (NCR)	TERRAIN	DON'T SINK or TOO LOW - TERRAIN	"Don't Sink" or "Too Low, Terrain"

The following system status annunciations may also be issued.

Alert Type	PFD/MFD TAWS Page Annunciation	MFD Pop-Up Alert	Aural Message
TAWS System Test Fail	TAWS FAIL	None	"TAWS System Failure"
TAWS Alerting is disabled	TAWS INHB	None	None
No GPS position or excessively degraded GPS signal	TAWS N/A	None	"TAWS Not Available"
System Test in progress	TAWS TEST	None	None
System Test pass	None	None	"TAWS System Test OK"

Alert Annunciations

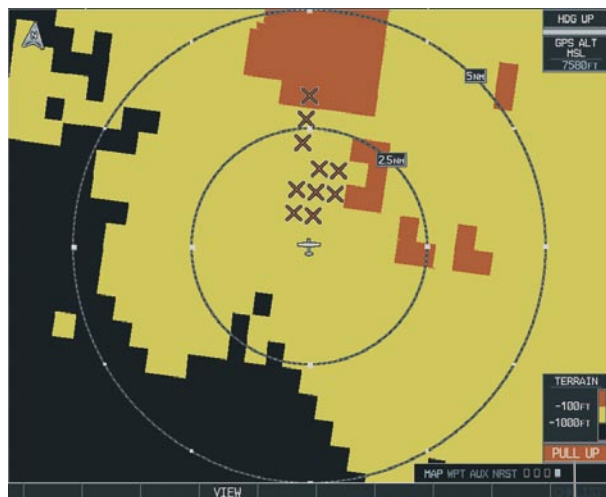

Alert Annunciation

Figure 10-27 Alert Annunciation on the TAWS Page



Figure 10-28 Alert Annunciation on the PFD

This page intentionally left blank.

SECTION 11: ABNORMAL OPERATION

11.1 REVERSIONARY MODE

Should a system detected failure occur in either display, the G1000 automatically enters reversionary mode. In reversionary mode, critical flight instrumentation is combined with engine instrumentation on the remaining display. Minimal navigation capability is available on the reversionary mode display.

Reversionary display mode can also be manually activated by the pilot if the system fails to detect a display problem. The reversionary mode is activated manually by pressing the red **DISPLAY BACKUP** button on the bottom of the audio panel (GMA 1347). Pressing the red **DISPLAY BACKUP** button again deactivates reversionary mode.



NOTE: *The Cessna Pilot's Operating Handbook (POH) always takes precedence over the information found in this section.*



Normal PFD Display



Normal MFD Display



MFD in Reversionary Mode

Figure 11-1 G1000 Reversionary Mode: Failed PFD

11.2 ABNORMAL COM OPERATION

When a COM tuning failure is detected by the system, the emergency frequency (121.500 MHz) is automatically loaded into the active frequency field of the COM radio for which the tuning failure was detected. In the event of a dual display failure, the emergency frequency (121.500 MHz) automatically becomes the active frequency to the pilot through the pilot headset.

11.3 UNUSUAL ATTITUDES

The PFD will 'declutter' when the aircraft enters an unusual attitude. Only the basic primary functions will be displayed in these situations.

Red extreme pitch warning chevrons pointing toward the horizon are displayed starting at 50 degrees above and 30 degrees below the horizon line.

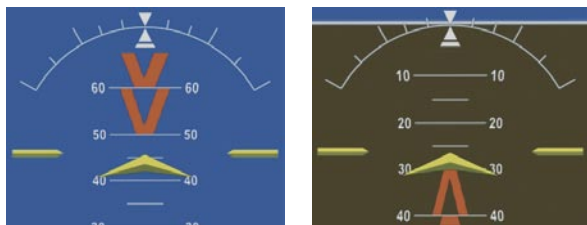

Figure 11-2 Extreme Pitch Indication

11.4 STORMSCOPE OPERATION WITH LOSS OF HEADING INPUT

If heading is lost, strikes and/or cells must be cleared manually after the execution of each turn. This is to ensure that the strike and/or cell positions are depicted accurately in relation to the nose of the aircraft.

SECTION 12: ANNUNCIATIONS & ALERTS



NOTE: The Cessna aircraft Pilot's Operating Handbook (POH) supersedes information found in this document.

The G1000 Alerting System conveys alerts to the pilot using a combination of the following items:

- **Annunciation Window:** The Annunciation window displays abbreviated annunciation text. Text color is based on alert levels described later in the Alert Levels Definitions section. The Annunciation window is located to the right of the Altitude and Vertical Speed windows on the display. All Cessna Nav III annunciations can be displayed simultaneously in the Annunciation window. A white horizontal line separates annunciations that are acknowledged from annunciations that are not yet acknowledged. Higher priority annunciations are displayed towards the top of the window. Lower priority annunciations are displayed towards the bottom of the window.
- **Alerts Window:** The Alerts window displays alert text messages. Up to 64 prioritized alert messages can be displayed in the Alerts window. Pressing the **ALERTS** softkey displays the Alerts window. Pressing the **ALERTS** softkey a second time removes the Alerts window from the display. When the Alerts window is displayed, the pilot can use the **large FMS** knob to scroll through the alert message list.
- **Softkey Annunciation:** During certain alerts, the **ALERTS** softkey may appear as a flashing annunciation to accompany an alert. The **ALERTS** softkey assumes a new label consistent with the alert level

(WARNING, CAUTION, or ADVISORY). By pressing the softkey annunciation, the pilot acknowledges awareness of the alert. The softkey then returns to the previous **ALERTS** label. If alerts are still present, the **ALERTS** label will be displayed in inverse video (white background with black text). The pilot can press the **ALERTS** softkey a second time to view alert text messages.

- **System Annunciations:** Typically, a large red 'X' appears in windows when a failure is detected in the LRU providing the information to the window. See the G1000 System Annunciations section for more information.
- **Audio Alerting System:** The G1000 system issues audio alert tones when specific system conditions are met. See the Alert Levels Definitions section for more information.

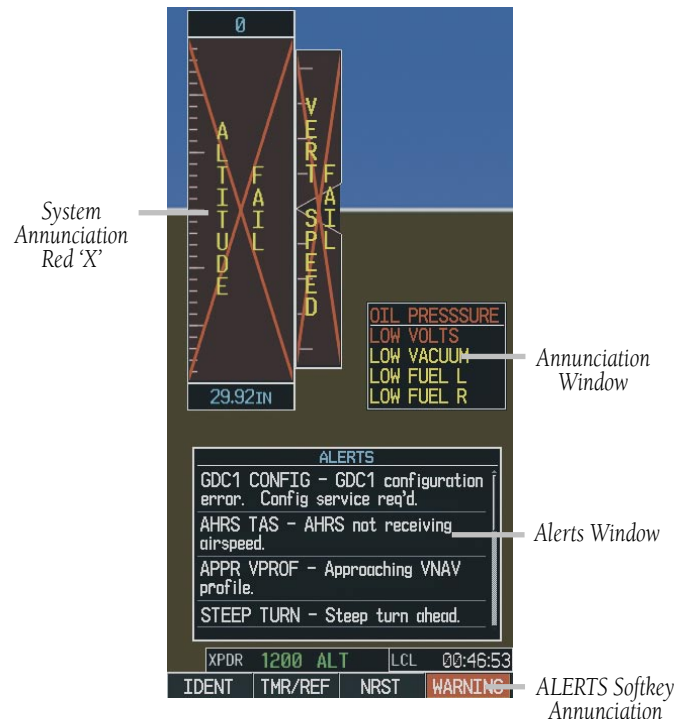

Figure 12-1 G1000 Alerting System

12.1 ALERT LEVEL DEFINITIONS

The G1000 Alerting System, as installed in Cessna Nav III aircraft, uses three alert levels.

- **WARNING:** This level of alert requires immediate pilot attention. A warning alert is annunciated in the Annunciation Window and is accompanied by a continuous aural tone. Text appearing in the Annunciation Window is RED. A warning alert is also accompanied by a flashing **WARNING** softkey annunciation, as shown in Figure 12-2. Pressing the **WARNING** softkey acknowledges the presence of the warning alert and stops the aural tone, if applicable.
- **CAUTION:** This level of alert indicates the existence of abnormal conditions on the aircraft that may require pilot intervention. A caution alert is annunciated in the Annunciation Window and is accompanied by a single aural tone. Text appearing in the Annunciation Window is YELLOW. A caution alert is also accompanied by a flashing **CAUTION** softkey annunciation, as shown in Figure 12-3. Pressing the **CAUTION** softkey acknowledges the presence of the caution alert.
- **MESSAGE ADVISORY:** This level of alert provides general information to the pilot. A message advisory alert does not issue annunciations in the Annunciation Window. Instead, message advisory alerts only issue a flashing **ADVISORY** softkey annunciation, as shown in Figure 12-4. Pressing the **ADVISORY** softkey acknowledges the presence of the message advisory alert and displays the alert text message in the Alerts Window.



Figure 12-2 WARNING Softkey Annunciation



Figure 12-3 CAUTION Softkey Annunciation

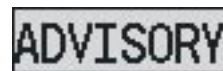

Figure 12-4 ADVISORY Softkey Annunciation

12.2 NAV III AIRCRAFT ALERTS

The following alerts are configured specifically for the Cessna Nav III aircraft. See the Cessna Pilot's Operating Handbook (POH) for information regarding pilot responses.

WARNING Alerts

Annunciation Window Text	Audio Alert
OIL PRESSURE	Continuous Aural Tone
LOW VOLTS	Continuous Aural Tone*
HIGH VOLTS	Continuous Aural Tone
CO LVL HIGH	Continuous Aural Tone
PITCH TRIM	No Tone

*Aural tone is inhibited while the aircraft is on the ground.

CAUTION Alerts

Annunciation Window Text	Audio Alert
LOW VACUUM	Single Aural Tone
LOW FUEL L	Single Aural Tone
LOW FUEL R	Single Aural Tone
STBY BATT	Single Aural Tone

CAUTION Alerts (T182, T206, and 206 with Prop De-Ice Only)

Annunciation Window Text	Audio Alert
PROP HEAT	Single Aural Tone

Safe Operating Annunciation (T182, T206, and 206 with Prop De-Ice Only)

Annunciation Window Text	Audio Alert
PROP HEAT	No Tone

12.3 CO GUARDIAN MESSAGES

Alerts Window Message	Comments
CO DET SRVC – The carbon monoxide detector needs service.	There is a problem within the CO Guardian that requires services.
CO DET FAIL – The carbon monoxide detector is inoperative.	Loss of communication between the G1000 and the CO Guardian.

12.4 TAWS ALERTS

The following table shows the possible TAWS alert types with corresponding annunciations and aural messages.

Alert Type	PFD/MFD TAWS Page Annunciation	MFD Pop-Up Alert	Aural Message
Excessive Descent Rate Warning (EDR)	PULL UP	PULL-UP	"Pull Up"
Reduced Required Terrain Clearance Warning (RTC)	PULL UP	TERRAIN - PULL-UP or TERRAIN AHEAD - PULL-UP	"Terrain, Terrain; Pull Up, Pull Up" or "Terrain Ahead, Pull Up; Terrain Ahead, Pull Up"
Imminent Terrain Impact Warning (ITI)	PULL UP	TERRAIN AHEAD - PULL-UP or TERRAIN - PULL-UP	Terrain Ahead, Pull Up; Terrain Ahead, Pull Up" or "Terrain, Terrain; Pull Up, Pull Up"
Reduced Required Obstacle Clearance Warning (ROC)	PULL UP	OBSTACLE - PULL-UP or OBSTACLE AHEAD - PULL-UP	"Obstacle, Obstacle; Pull Up, Pull Up" or "Obstacle Ahead, Pull Up; Obstacle Ahead, Pull Up"
Imminent Obstacle Impact Warning (IOI)	PULL UP	OBSTACLE AHEAD - PULL-UP or OBSTACLE - PULL-UP	"Obstacle Ahead, Pull Up; Obstacle Ahead, Pull Up" or "Obstacle, Obstacle; Pull Up, Pull Up"
Reduced Required Terrain Clearance Caution (RTC)	TERRAIN	CAUTION - TERRAIN or TERRAIN AHEAD	"Caution, Terrain; Caution, Terrain" or "Terrain Ahead; Terrain Ahead"
Imminent Terrain Impact Caution (ITI)	TERRAIN	TERRAIN AHEAD or CAUTION - TERRAIN	"Terrain Ahead; Terrain Ahead" or "Caution, Terrain; Caution, Terrain"
Reduced Required Obstacle Clearance Caution (ROC)	TERRAIN	CAUTION - OBSTACLE or OBSTACLE AHEAD	"Caution, Obstacle; Caution, Obstacle" or "Obstacle Ahead; Obstacle Ahead"
Imminent Obstacle Impact Caution (IOI)	TERRAIN	OBSTACLE AHEAD or CAUTION - OBSTACLE	"Obstacle Ahead; Obstacle Ahead" or "Caution, Obstacle; Caution, Obstacle"
Premature Descent Alert Caution (PDA)	TERRAIN	TOO LOW - TERRAIN	"Too Low, Terrain"
Altitude Callout "500"	None	None	"Five-Hundred"
Excessive Descent Rate Caution (EDR)	TERRAIN	SINK RATE	"Sink Rate"
Negative Climb Rate Caution (NCR)	TERRAIN	DON'T SINK or TOO LOW - TERRAIN	"Don't Sink" or "Too Low, Terrain"

The following system status annunciations may also be issued.

Alert Type	PFD/MFD TAWS Page Annunciation	MFD Pop-Up Alert	Aural Message
TAWS System Test Fail	TAWS FAIL	None	"TAWS System Failure"
TAWS Alerting is disabled	TAWS INHB	None	None
No GPS position or excessively degraded GPS signal	TAWS N/A	None	"TAWS Not Available"
System Test in progress	TAWS TEST	None	None
System Test pass	None	None	"TAWS System Test OK"

12.5 G1000 SYSTEM ANNUNCIATIONS

When an LRU or an LRU function fails, a large red 'X' is typically displayed on windows associated with the failed data. Refer to the POH for additional information regarding pilot responses to these annunciations.



NOTE: Upon power-up of the G1000 system, certain windows remain invalid as G1000 equipment begins to initialize. All windows should be operational within one minute of power-up. Should any window continue to remain flagged, the G1000 system should be serviced by a Garmin-authorized repair facility.



Traffic Voice Alerts





The following voice alerts can be configured for 'Male' or 'Female' gender by using the Aux System Setup Page on the MFD.

Voice Alert	Alert Trigger
"Traffic"	Played when a Traffic Advisory (TA) is issued.
"Traffic Not Available"	Played when the traffic system fails or cannot communicate.



NOTE: Voice alerts are provided to the G1000 by GIA 63 #1. Should this unit fail, audio and voice alerts will no longer be available.

System Annunciation	Comment
	Attitude and Heading Reference System is aligning.
	Display system is not receiving attitude information from the AHRS.
	Display system is not receiving airspeed input from air data computer.

System Annunciation	Comment
	<p>Display is not receiving altitude input from the air data computer.</p>
	<p>Display is not receiving vertical speed input from the air data computer.</p>
	<p>Display is not receiving valid heading input from AHRS.</p>
	<p>GPS information is either not present or is invalid for navigation use. Note that AHRS utilizes GPS inputs during normal operation. AHRS operation may be degraded if GPS signals are not present (see AFMS).</p>
	<p>Display is not receiving valid transponder information.</p>
<p>Other Various Red X Indications</p>	<p>A red 'X' through any other display field, such as engine instrumentation fields, indicates that the field is not receiving valid data.</p>

A red 'X' may be the result of an LRU or an LRU function failure. The Figure 12-5 illustrates all possible flags and the responsible LRUs.

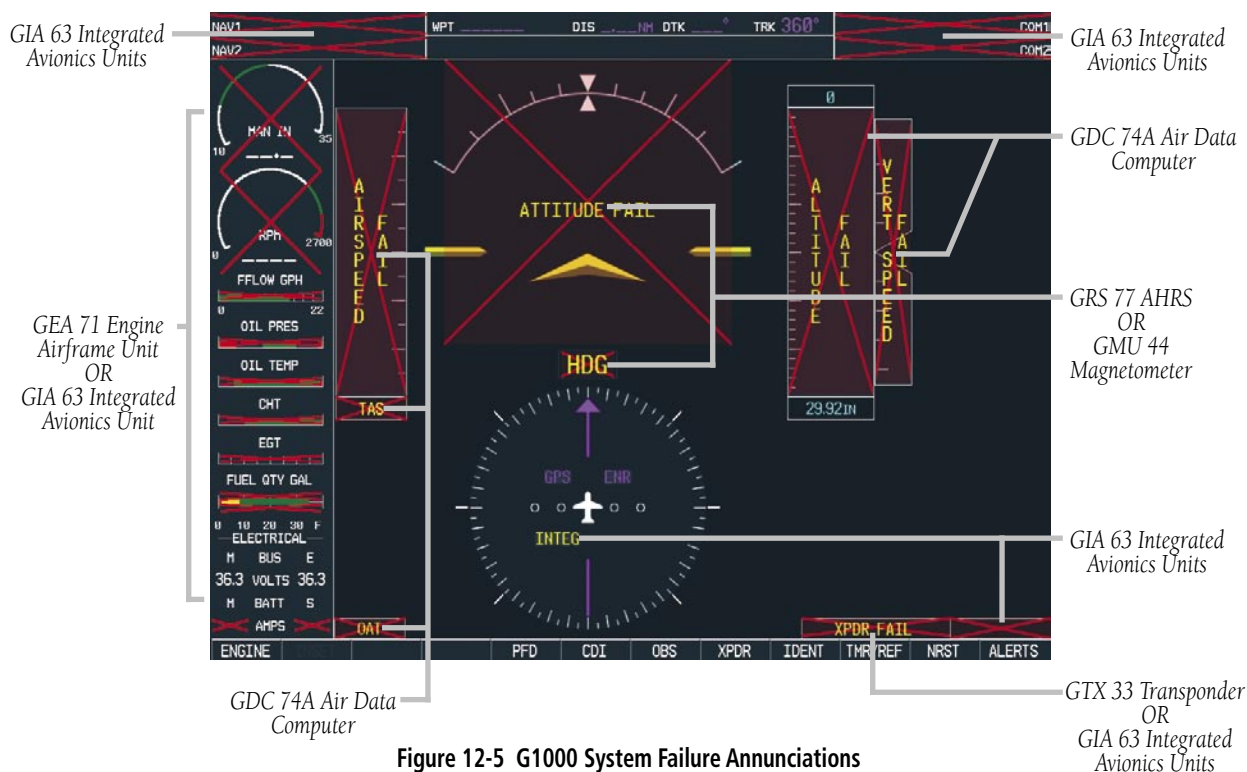

Figure 12-5 G1000 System Failure Annunciations

12.6 G1000 SYSTEM MESSAGE ADVISORIES

This section describes various G1000 system message advisories. Certain messages are issued due to an LRU or an LRU function failure. Such messages are normally accompanied by a corresponding red 'X' annunciation as shown previously in the G1000 System Annunciation section.



NOTE: This section provides information regarding G1000 message advisories that may be displayed by the system. Knowledge of the aircraft, systems, flight conditions, and other existing operational priorities must be considered when responding to a message. Always use sound pilot judgment. The Cessna aircraft Pilot's Operating Handbook (POH) takes precedence over any conflicting guidance found in this section.

MFD & PFD Message Advisories

Message	Comments
DATA LOST – Pilot stored data was lost. Recheck settings.	The pilot profile data was lost. System reverts to default pilot profile and settings. The pilot may reconfigure the MFD & PFD with preferred settings, if desired.
XTALK ERROR – A flight display crosstalk error has occurred.	The MFD and PFD are not communicating with each other. The G1000 system should be serviced.
PFD1 SERVICE – PFD1 needs service. Return unit for repair.	The PFD and/or MFD self-test has detected a problem. The G1000 system should be serviced.
MFD1 SERVICE – MFD1 needs service. Return unit for repair.	
PFD1 CONFIG – PFD1 configuration error. Config service req'd.	The PFD and/or MFD configuration settings do not match backup configuration memory. The G1000 system should be serviced.
MFD1 CONFIG – MFD1 configuration error. Config service req'd.	
SW MISMATCH – GDU software mismatch. Xtalk is off.	The MFD and PFD have different software versions installed. The G1000 system should be serviced.
MANIFEST – PFD1 software mismatch. Communication halted.	The PFD and/or MFD has incorrect software installed. The G1000 system should be serviced.
MANIFEST – MFD1 software mismatch. Communication halted.	
PFD1 COOLING – PFD1 has poor cooling. Reducing power usage.	The PFD and/or MFD is overheating and is reducing power consumption by dimming the display. If problem persists, the G1000 system should be serviced.
MFD1 COOLING – MFD1 has poor cooling. Reducing power usage.	
PFD1 "KEY" KEYSTK – Key is stuck.	A key is stuck on the PFD and/or MFD bezel. Attempt to free the stuck key by pressing it several times. The G1000 system should be serviced if the problem persists.
MFD1 "KEY" KEYSTK – Key is stuck.	
CNFG MODULE – PFD1 configuration module is inoperative.	The PFD configuration module backup memory has failed. The G1000 system should be serviced.

Database Message Advisories

Alerts Window Message	Comments
MFD1 DB ERR – MFD1 aviation database error exists.	The MFD and/or PFD detected a failure in the aviation database. Attempt to reload the aviation database. If problem persists, the G1000 system should be serviced.
PFD1 DB ERR – PFD1 aviation database error exists.	
MFD1 DB ERR – MFD1 basemap database error exists.	The MFD and/or PFD detected a failure in the basemap database.
PFD1 DB ERR – PFD1 basemap database error exists.	
MFD1 DB ERR – MFD1 terrain database error exists.	The MFD and/or PFD detected a failure in the terrain database. Ensure that the terrain card is properly inserted in display. Replace terrain card. If problem persists, The G1000 system should be serviced.
PFD1 DB ERR – PFD1 terrain database error exists.	
DB MISMATCH – Aviation database version mismatch. Xtalk is off.	The PFD and MFD have different aviation database versions installed. Crossfill is off. Install correct aviation database version in both displays.
DB MISMATCH – Aviation database type mismatch. Xtalk is off.	The PFD and MFD have different aviation database types installed (Americas, European, etc.). Crossfill is off. Install correct aviation database type in both displays.
DB MISMATCH – Basemap database version mismatch. Xtalk is off.	The PFD and MFD have different basemap database versions installed. Crossfill is off. Install correct basemap database version in both displays.
DB MISMATCH – Terrain database version mismatch. Xtalk is off.	The PFD and MFD have different terrain database versions installed. Crossfill is off. Install correct terrain database version in both displays.
DB MISMATCH – Terrain database type mismatch. Xtalk is off.	The PFD and MFD have different terrain database types installed. Crossfill is off. Install correct terrain database type in both displays.
DB MISMATCH – Obstacle database version mismatch. Xtalk is off.	The PFD and MFD have different obstacle database versions installed. Crossfill is off. Install correct obstacle database version in both displays.
DB MISMATCH – Airport Terrain database mismatch. Xtalk is off.	The PFD and MFD have different airport terrain databases installed. Crossfill is off. Install correct airport terrain database in both displays.

GMA 1347 Message Advisories

Alerts Window Message	Comments
GMA1 FAIL – GMA1 is inoperative.	The audio panel self-test has detected a failure. The audio panel is unavailable. The G1000 system should be serviced.
GMA1 CONFIG – GMA1 configuration error. Config service req'd.	The audio panel configuration settings do not match backup configuration memory. The G1000 system should be serviced.
MANIFEST – GMA1 software mismatch. Communication halted.	The audio panel has incorrect software installed. The G1000 system should be serviced.
GMA1 SERVICE – GMA1 needs service. Return unit for repair.	The audio panel self-test has detected a problem in the unit. Certain audio functions may still be available, and the audio panel may still be usable. The G1000 system should be serviced when possible.
BACKUP PATH – Audio panel 1 using backup data path.	The #1 audio panel is using a backup communication path. The G1000 system should be serviced when possible.

GIA 63 Message Advisories

Alerts Window Message	Comments
GIA1 CONFIG – GIA1 configuration error. Config service req'd.	The GIA1 and/or GIA2 configuration settings do not match backup configuration memory. The G1000 system should be serviced.
GIA2 CONFIG – GIA2 configuration error. Config service req'd.	
GIA1 COOLING – GIA1 temperature too low.	The GIA1 and/or GIA2 temperature is too low to operate correctly. Allow units to warm up to operating temperature.
GIA2 COOLING – GIA2 temperature too low.	
GIA1 COOLING – GIA1 over temperature.	The GIA1 and/or GIA2 temperature is too high. If problem persists, the G1000 system should be serviced.
GIA2 COOLING – GIA2 over temperature.	
GIA1 SERVICE – GIA1 needs service. Return the unit for repair.	The GIA1 and/or GIA2 self-test has detected a problem in the unit. The G1000 system should be serviced.
GIA2 SERVICE – GIA2 needs service. Return the unit for repair.	

GIA 63 Message Advisories (Cont.)

Alerts Window Message	Comments
MANIFEST – GIA1 software mismatch. Communication halted.	The GIA1 and/or GIA 2 has incorrect software installed. The G1000 system should be serviced.
MANIFEST – GIA2 software mismatch. Communication halted.	
COM1 TEMP – COM1 over temp. Reducing transmitter power.	The system has detected an over temperature condition in COM1 and/or COM2. The transmitter will operate at reduced power. If the problem persists, the G1000 system should be serviced.
COM2 TEMP – COM2 over temp. Reducing transmitter power.	
COM1 SERVICE – COM1 needs service. Return unit for repair.	The system has detected a failure in COM1 and/or COM2. COM1 and/or COM2 may still be usable. The G1000 system should be serviced when possible.
COM2 SERVICE – COM2 needs service. Return unit for repair.	
COM1 PTT – COM1 push-to-talk key is stuck.	The COM1 and/or COM2 external push-to-talk switch is stuck in the enable (or “pressed”) position. Press the PTT switch again to cycle its operation. If the problem persists, the G1000 system should be serviced.
COM2 PTT – COM2 push-to-talk key is stuck.	
COM1 RMT XFR – COM1 remote transfer key is stuck.	The COM1 and/or COM2 transfer switch is stuck in the enabled (or “pressed”) position. Press the transfer switch again to cycle its operation. If the problem persists, the G1000 system should be serviced.
COM2 RMT XFR – COM2 remote transfer key is stuck.	
RAIM UNAVAIL – RAIM is not available from FAF to MAP waypoints.	GPS satellite coverage is insufficient to perform Receiver Autonomous Integrity Monitoring (RAIM) from the FAF to the MAP waypoints.
RAIM UNAVAIL – RAIM is not available.	GPS satellite coverage is insufficient to perform Receiver Autonomous Integrity Monitoring (RAIM) for the current phase of flight.
POSN ERROR – RAIM has determined GPS position is in error.	When a RAIM position error is detected, GPS is flagged and the system no longer provides GPS-based guidance.
DGRD GPS ACC – GPS position accuracy degraded & RAIM unavailable.	GPS position accuracy has been degraded and RAIM is not available.
GPS1 FAIL – GPS1 is inoperative.	A failure has been detected in the GPS1 and/or GPS2 receiver. The receiver is unavailable. The G1000 system should be serviced.
GPS2 FAIL – GPS2 is inoperative.	

GIA 63 Message Advisories (Cont.)

Alerts Window Message	Comments
GPS1 SERVICE – GPS1 needs service. Return unit for repair.	A failure has been detected in the GPS1 and/or GPS2 receiver. The receiver may still be available. The G1000 system should be serviced.
GPS2 SERVICE – GPS2 needs service. Return unit for repair.	
NAV1 SERVICE – NAV1 needs service. Return unit for repair.	A failure has been detected in the NAV1 and/or NAV2 receiver. The receiver may still be available. The G1000 system should be serviced.
NAV2 SERVICE – NAV2 needs service. Return unit for repair.	
NAV1 RMT XFR – NAV1 remote transfer key is stuck.	The remote NAV1 and/or NAV2 transfer switch is stuck in the enabled (or “pressed”) state. Press the transfer switch again to cycle its operation. If the problem persists, the G1000 system should be serviced.
NAV2 RMT XFR – NAV2 remote transfer key is stuck.	
G/S1 FAIL – G/S1 is inoperative.	A failure has been detected in glideslope receiver 1 and/or receiver 2. The G1000 system should be serviced.
G/S2 FAIL – G/S2 is inoperative.	
G/S1 SERVICE – G/S1 needs service. Return unit for repair.	A failure has been detected in glideslope receiver 1 and/or receiver 2. The receiver may still be available. The G1000 system should be serviced when possible.
G/S2 SERVICE – G/S2 needs service. Return unit for repair.	

GEA 71 Message Advisories

Alerts Window Message	Comments
GEA1 CONFIG – GEA1 configuration error. Config service req'd.	The GEA 71 configuration settings do not match those of backup configuration memory. The G1000 system should be serviced.
MANIFEST – GEA1 software mismatch. Communication halted.	The GEA 71 has incorrect software installed. The G1000 system should be serviced.
BACKUP PATH – EIS using backup data path.	The GEA 71 is using a backup communication path. The G1000 system should be serviced when possible.

GTX 33 Message Advisories

Alerts Window Message	Comments
XPDR1 CONFIG – XPDR1 config error. Config service req'd.	The transponder configuration settings do not match those of backup configuration memory. The G1000 system should be serviced.
MANIFEST – GTX1 software mismatch. Communication halted.	The transponder has incorrect software installed. The G1000 system should be serviced.
BACKUP PATH – XPDR1 using backup data path.	The #1 transponder is using a backup communications path. The G1000 system should be serviced when possible.

GRS 77 Message Advisories

Alerts Window Message	Comments
AHRS1 TAS – AHRS1 not receiving airspeed.	The #1 AHRS is not receiving true airspeed from the air data computer. The AHRS relies on GPS information to augment the lack of airspeed. The G1000 system should be serviced.
AHRS1 GPS – AHRS1 using backup GPS source.	The #1 AHRS is using the backup GPS path. Primary GPS path has failed. The G1000 system should be serviced when possible.
AHRS1 GPS – AHRS1 not receiving any GPS information.	The #1 AHRS is not receiving any or any useful GPS information. Check AFMS limitations. The G1000 system should be serviced.
AHRS1 GPS – AHRS1 not receiving backup GPS information.	The #1 AHRS is not receiving backup GPS information. The G1000 system should be serviced.
AHRS1 GPS – AHRS1 operating exclusively in no-GPS mode.	The #1 AHRS is operating exclusively in no-GPS mode. The G1000 system should be serviced.
MANIFEST – GRS1 software mismatch. Communication halted.	The AHRS has incorrect software installed. The G1000 system should be serviced.
BACKUP PATH – AHRS1 using backup data path.	The #1 AHRS is using a backup communications data path. The G1000 system should be serviced when possible.
AHRS1 SRVC – AHRS1 Magnetic-field model needs update.	The #1 AHRS earth magnetic field model is out of date. Update magnetic field model when practical.
GEO LIMITS – AHRS1 too far North/South, no magnetic compass.	The aircraft is outside geographical limits for approved AHRS operation. Heading is flagged as invalid.

GMU 44 Message Advisories

Alerts Window Message	Comments
HDG FAULT – AHRS1 magnetometer fault has occurred.	A fault has occurred in the GMU 44. Heading is flagged as invalid. The AHRS uses GPS for backup mode operation. The G1000 system should be serviced.
MANIFEST – GMU1 software mismatch. Communication halted.	The GMU 44 has incorrect software installed. The G1000 system should be serviced.

GDL 69 Message Advisories

Alerts Window Message	Comments
GDL69 CONFIG – GDL 69 configuration error. Config service req'd.	GDL 69 configuration settings do not match those of backup configuration memory. The G1000 system should be serviced.
GDL69 FAIL – GDL 69 has failed.	A failure has been detected in the GDL 69. The receiver is unavailable. The G1000 system should be serviced

GDC 74A Message Advisories

Alerts Window Message	Comments
GDC1 CONFIG – GDC1 configuration error. Config service req'd.	GDC 74A configuration settings do not match those of backup configuration memory. The G1000 system should be serviced.
MANIFEST – GDC1 software mismatch. Communication halted.	The GDC 74A has incorrect software installed. The G1000 system should be serviced.
BACKUP PATH – ADC1 using backup data path.	The GDC 74A is using a backup communications data path. The G1000 system should be serviced when possible.

Miscellaneous Message Advisories

Alerts Window Message	Comments
FPL WPT LOCK – Flight plan waypoint is locked.	Upon power-up, the G1000 system detects that a stored flight plan waypoint is locked. This occurs when an aviation database update eliminates an obsolete waypoint. The flight plan cannot find the specified waypoint and flags this message. This can also occur with user waypoints in a flight plan that is deleted. Remove the waypoint from the flight plan if it no longer exists in any database, OR update the waypoint name/identifier to reflect the new information.
FPL WPT MOVE – Flight plan waypoint moved.	The system has detected that a waypoint coordinate has changed due to a new aviation database update. Verify that stored flight plans contain correct waypoint locations.
TIMER EXPIRD – Timer has expired.	The system notifies the pilot that the timer has expired.
DB CHANGE – Database changed. Verify user modified procedures.	This occurs when a stored flight plan contains procedures that have been manually edited. This alert is issued only after an aviation database update. Verify that the user-modified procedures in stored flight plans are correct and up to date.
FPL TRUNC – Flight plan has been truncated.	This occurs when a newly installed aviation database eliminates an obsolete approach or arrival used by a stored flight plan. The obsolete procedure is removed from the flight plan. Update flight plan with current arrival or approach.
APPR VPROF – Approaching VNAV profile.	Aircraft is approaching VNAV profile. Prepare to climb or descend to meet VNAV profile.
APPR TRG ALT – Approaching target altitude.	Aircraft is approaching target altitude. Prepare to level aircraft.
LOCKED FPL – Cannot navigate locked flight plan.	This occurs when the pilot attempts to activate a stored flight plan that contains locked waypoint. Remove locked waypoint from flight plan. Update flight plan with current waypoint.
WPT ARRIVAL – Arriving at waypoint -[xxxx]	Arriving at waypoint [xxxx], where [xxxx] is the waypoint name.
STEEP TURN – Steep turn ahead.	A steep turn is 15 seconds ahead. Prepare to turn.
INSIDE ARSPC – Inside airspace.	The aircraft is inside the airspace.
ARSPC AHEAD – Airspace ahead less than 10 minutes.	Special use airspace is ahead of aircraft. The aircraft will penetrate the airspace within 10 minutes.
ARSPC NEAR – Airspace near and ahead.	Special use airspace is near and ahead of the aircraft position.

Miscellaneous Message Advisories (Cont.)

Alerts Window Message	Comments
ARSPC NEAR – Airspace near – less than 2 nm.	Special use airspace is within 2 nm of the aircraft position.
LEG UNSMOOTH – Flight plan leg will not be smooth.	The approaching flight plan waypoints are too close to allow for smooth turns. Prepare for steep turns ahead and expect noticeable course deviations.
APPR INACTV – Approach is not active.	The system notifies the pilot that the loaded approach is not active. Activate approach when required.
SLCT AUTOSEQ – Select auto sequence mode.	The system notifies the pilot to select auto-sequence mode. Press the OBS softkey to deactivate the OBS mode.
SLCT FREQ – Select appropriate frequency for approach.	The system notifies the pilot to load the approach frequency for the appropriate NAV receiver. Select the correct frequency for the approach.
SLCT NAV – Select NAV on CDI for approach.	The system notifies the pilot to set the CDI to the correct NAV receiver. Set the CDI to the correct NAV receiver.
NO WGS84 WPT – Non WGS 84 waypoint for navigation -[xxxx]	The selected waypoint [xxxx] does not use the WGS 84 datum. Cross-check position with alternate navigation sources.
TRAFFIC FAIL – Traffic device has failed.	The traffic information system TIS has failed. The G1000 system should be serviced.
STRMSCP FAIL – Stormscope has failed.	Stormscope has failed. The G1000 system should be serviced.
BACKUP PATH – Stormscope using backup path.	Stormscope is using the backup communication path. The G1000 system should be serviced when possible.
LOCKED FPL – Cannot navigate locked flight plan.	This occurs when the pilot attempts to activate a stored flight plan that contains locked waypoint. Remove locked waypoint from flight plan. Update flight plan with current waypoint.
WPT ARRIVAL – Arriving at waypoint -[xxxx]	Arriving at waypoint [xxxx], where [xxxx] is the waypoint name.
STEEP TURN – Steep turn ahead.	A steep turn is 15 seconds ahead. Prepare to turn.
INSIDE ARSPC – Inside airspace.	The aircraft is inside the airspace.
ARSPC AHEAD – Airspace ahead less than 10 minutes.	Special use airspace is ahead of aircraft. The aircraft will penetrate the airspace within 10 minutes.
ARSPC NEAR – Airspace near and ahead.	Special use airspace is near and ahead of the aircraft position.

Miscellaneous Message Advisories (Cont.)

Alerts Window Message	Comments
ARSPC NEAR – Airspace near – less than 2 nm.	Special use airspace is within 2 nm of the aircraft position.
LEG UNSMOOTH – Flight plan leg will not be smooth.	The approaching flight plan waypoints are too close to allow for smooth turns. Prepare for steep turns ahead and expect noticeable course deviations.
APPR INACTV – Approach is not active.	The system notifies the pilot that the loaded approach is not active. Activate approach when required.
SLCT AUTOSEQ – Select auto sequence mode.	The system notifies the pilot to select auto-sequence mode. Press the OBS softkey to deactivate the OBS mode.
SLCT FREQ – Select appropriate frequency for approach.	The system notifies the pilot to load the approach frequency for the appropriate NAV receiver. Select the correct frequency for the approach.
SLCT NAV – Select NAV on CDI for approach.	The system notifies the pilot to set the CDI to the correct NAV receiver. Set the CDI to the correct NAV receiver.
NO WGS84 WPT – Non WGS 84 waypoint for navigation -[xxxx]	The selected waypoint [xxxx] does not use the WGS 84 datum. Cross-check position with alternate navigation sources.
TRAFFIC FAIL – Traffic device has failed.	The traffic information system TIS has failed. The G1000 system should be serviced.
STRMSCP FAIL – Stormscope has failed.	Stormscope has failed. The G1000 system should be serviced.
BACKUP PATH – Stormscope using backup path.	Stormscope is using the backup communication path. The G1000 system should be serviced when possible.

A

Abnormal COM operation 11-2
 Activate a flight plan 8-2
 Active flight plan 8-2
 ADF 1-4, 1-5, 5-2
 Age 10-6
 AHRS 12-14
 Aircraft alerts 12-3
 AIRMET 10-5
 Airport frequency 7-6
 Airport information 7-3
 Airspace alerts 7-9
 Airspeed indicator 2-3
 Airspeed trend vector 2-3
 Alerting system 12-1
 Alerts 12-1
 Alert levels 12-2
 Alert Pop-Up 10-15
 Altitude mode 10-8
 Altitude reference bug 2-4
 Altitude trend vector 2-4
 Altitude volume 10-8
 ALT knob 1-3
 Approaches 9-2
 Approach activation 4-4
 Approach markers
 Signal augmentation 5-2
 Arrivals 9-1
 ASSIST 3-1
 Attitude indicator 2-3
 Audio alerting system 12-1
 Audio panel 4-3, 5-1
 Audio panel controls
 ADF 5-2
 DME 5-2
 NAV1 5-2
 NAV2 5-2
 Auto-tuning 4-3, 4-4
 Automatic squelch 4-3

B

Barometric setting 2-4

Base reflectivity 10-4
 BKSP softkey 4-4
 BRG1 2-6
 BRG2 2-6

C

CAUTION 12-2
 Caution alerts 12-3
 CDI 2-7, 12-17, 12-18
 Cell 10-2
 Cell mode 10-2
 Cell movement 10-5
 Cloud Tops 10-4
 CLR key 1-3
 Coast mode 10-7
 Codes (important) 4-5
 Code selection 4-4
 CODE softkey 4-4
 COM frequency window 4-1
 COM knob 4-3
 Controls (display bezel) 1-2
 Create a new flight plan 8-3, 8-4
 Create a new user waypoint 8-1
 Cyclones 10-5
 Cylinder select 3-1
 CYL SLCT 3-1

D

Departures 9-1
 Direct-to 7-1
 DME 1-5
 Dual CDU failure 11-2

E

ECHO TOPS 10-4
 Edit a flight plan 8-5
 EDR 10-14
 Emergency code 4-5
 Engine display 3-1
 ENGINE softkey 3-1
 Excessive Descent Rate 10-14

F

Five-Hundred Aural Alert 10-14
 Flight ID 4-5
 Flight Plan Catalog 9-1, 9-2
 FLTA 10-12
 Forward Looking Terrain Avoidance
 10-12
 FPL key 1-3
 Freezing level 10-5
 Frequency toggle key 1-3, 4-3

G

GMA 1347 1-1

H

Heading indication 2-6
 Headset(s) 5-2
 Hijack code 4-5
 Horizontal situation indicator 2-5
 HSI 2-5
 Hurricanes 10-5

I

ICAO 4-5
 ID 4-3
 IDENT function 4-5
 Imminent Terrain Impact 10-12
 Impact point 10-12
 Inhibit 10-12
 Inhibit TAWS 10-12
 INTEG 2-7
 Interrogations 4-4
 IOI 10-12, 10-13, 10-16, 12-4
 ITI 10-12

J

Joystick (bezel) 1-2

K

Key(s) 1-3
 CLR 1-2
 COM Frequency Toggle 1-2
 Direct-to 1-2
 ENT 1-2
 FPL 1-2
 MENU 1-2
 NAV Frequency Toggle 1-2
 PROC 1-2
 Knob(s)
 ALT 1-2
 COM 1-2
 COM VOL/SQ 1-2
 CRS/BARO 1-2
 FMS 1-2
 HDG 1-2
 NAV 1-2
 NAV VOL/ID 1-2

L

Lighted obstacle 10-15
 Lightning 1-4, 1-7, 10-2, 10-3, 10-4
 Load approach 8-4
 Load a VOR frequency 7-8
 Load departure 8-4
 Load the frequency for a controlling agency 7-9
 Load the nearest ARTCC frequency 7-9
 Loss of communication code 4-5

M

MAP 7-1
 Map panning 10-5
 Marker beacon 2-4
 Message advisories 12-2, 12-9–12-18
 METAR 10-3, 10-5
 MFD 1-1, 4-4
 Military interceptor operations code 4-5
 MKR/MUTE 5-2
 Mode selection softkeys 4-4

Morse code identifier 4-3

N

Nav/Com controls 4-1
 NAV1 5-2
 NAV2 5-2
 Navigation 7-1
 Navigation status window 2-2
 NAV frequency window 4-1
 NCR 10-14
 Nearest Airports Page 7-3, 7-5–7-9, 8-1
 Nearest ARTCC & FSS frequencies 7-8
 Negative Climb Rate After Takeoff 10-14
 NEXRAD 1-4, 1-7, 10-3, 10-4, 10-5, 10-6

O

OBS 2-7
 Obstacles 10-9, 10-10, 10-15, 12-10
 Operation 5-2
 Optional
 NAV radios 4-3

P

Page group icon 1-8
 PDA 10-13
 PFD 1-1, 4-1, 4-4
 PLAY key 5-4
 Premature Descent Alert 10-13
 PROC key 1-3

R

Red pointer 2-3
 Remove departure, arrival, or approach 8-5
 Replies 4-4
 Reversionary mode 5-1, 11-1
 Revision v
 ROC 10-12, 10-13, 10-16, 12-4
 RTC 10-12

R indication 4-4

S

Severe thunderstorm 10-5
 SIGMET 10-5
 Slip/Skid indicator 2-3
 Softkey function (MFD) 1-4, 1-6
 Speed ranges 2-3
 Squelch 5-3
 Store Flight Plan 8-5
 Stormscope lightning data 1-4, 1-7, 10-1, 10-2, 10-3
 Strike 10-2
 Strike mode 10-2
 System annunciations 12-1
 System message advisories 12-8

T

TA 10-7, 12-6
 TAF 10-3
 TAS 1-4, 10-7, 10-8, 10-9, 12-14
 TAWS 10-10, 10-11, 10-12, 10-15, 10-16, 10-17, 12-4, 12-5
 TAWS-B 10-10
 TAWS system test 10-12
 Terrain 10-9, 10-10, 10-15, 10-17, 12-10
 Terrain proximity 10-9
 TIS 1-4, 10-7, 12-17
 Tornado 10-5
 Trademark i
 Traffic advisory 10-7, 10-8, 10-9, 10-17, 12-6
 Traffic map page 10-7, 10-8, 10-9, 10-10, 10-14
 Transponder 4-4
 Transponder Status bar 4-4
 Trend vector 2-6
 Tropical storms 10-5
 Turn rate indicator 2-6
 TX 4-3

U

Unlighted obstacle 10-15

V

Vertical Deviation/Glideslope indicator 2-4

Vertical navigation profile 8-8

VFR code 4-5

VHF 4-1

Voice alerts 12-3

VOL/PUSH ID 4-2

VOL/PUSH SQ 4-2, 4-3

Volume/squelch 5-3

Vspeeds 2-3

W

WARN 2-7

WARNING 12-2

Warning alerts 12-3

Weather data link page 10-4

Weather product symbol 10-5

Weather product symbols 10-6

Weather warnings 10-5

Wind direction 10-5

Wind speed 10-5

X

XM weather 10-3

XPDR softkey 4-4

This page intentionally left blank.



Garmin International, Inc.
1200 East 151st Street
Olathe, KS 66062, U.S.A.
p: 913.397.8200 f: 913.397.8282

Garmin AT, Inc.
2345 Turner Road SE
Salem, OR 97302, U.S.A.
p: 503.391.3411 f: 503.364.2138

Garmin (Europe) Ltd.
Unit 5, The Quadrangle
Abbey Park Industrial Estate
Romsey, SO51 9DL, U.K.
p: 44/0870.8501241 f: 44/0870.8501251

Garmin Corporation
No. 68, Jangshu 2nd Road
Shijr, Taipei County, Taiwan
p: 886/2.2642.9199 f: 886/2.2642.9099

www.garmin.com